

Welcome

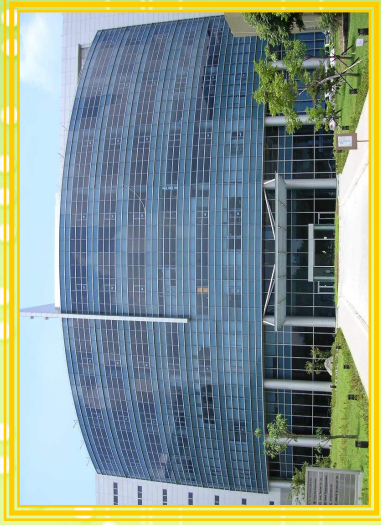

Welcome

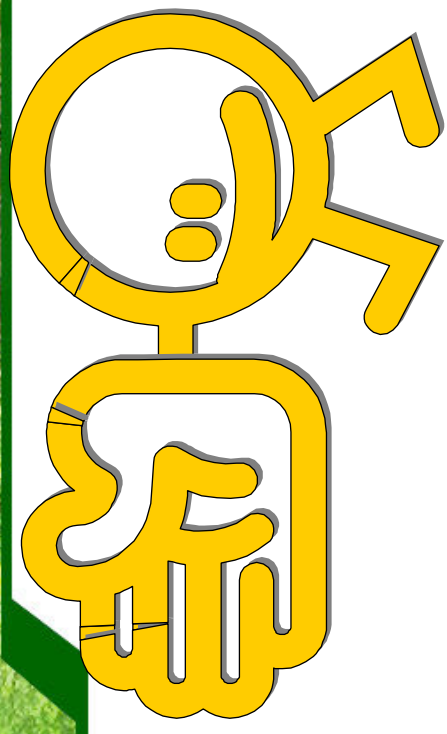

YoungTek Electronics Corp.

Stock No: 6261

Brief Introduction

Spokesman : Tony Liu
Date : 26 October, 2010



2010 Investor Conference Schedule @ 久元

Company Profile

Contents

Time

- | | |
|------------------------------|-------------|
| □ Brief Introduction of YTEC | 14:00~14:25 |
| □ Q & A | 14:25~15:00 |

Contents

Company Profile

- **Brief Introduction**
- **Factory Overview**
- **Company Milestone**
- **Company Management Concept**
- **OEM Services**
- **Own Product Development**
- **Revenue Growth & Business Expansion Review**
- **Company Mission**



Brief Introduction

Company Profile

Found Time : 1991/July

Chairman : Bily Wang

President of Service Group : Jeff Chang

President of Own Product Group : Glen Chen

Employees : 946

Capital : NTD 956 million (USD 30.8 million)

Address : Plant 1(1F~5F) : Special & substrate sawing

An Ping Plant (3F) : LED sorting

Li Hsin Plant (2F~3F) : LED back-end turn-key service

SBIP Plant (1~4F、7F) : IC back-end turn-key service, ATE&AOI

Business Items :

- Semiconductor and LED OEMs**: Wafer sawing, grinding, sorting and IC testing, LED testing, laser scribing, sorting and substrate sawing.
- Design, manufacture and sales of semiconductor equipments**: CIS/CCM equipments, AOI system, full-function IC tester, logic IC tester, analog IC tester, Mixed-Signal IC Tester , LED tester, prober and sorter.

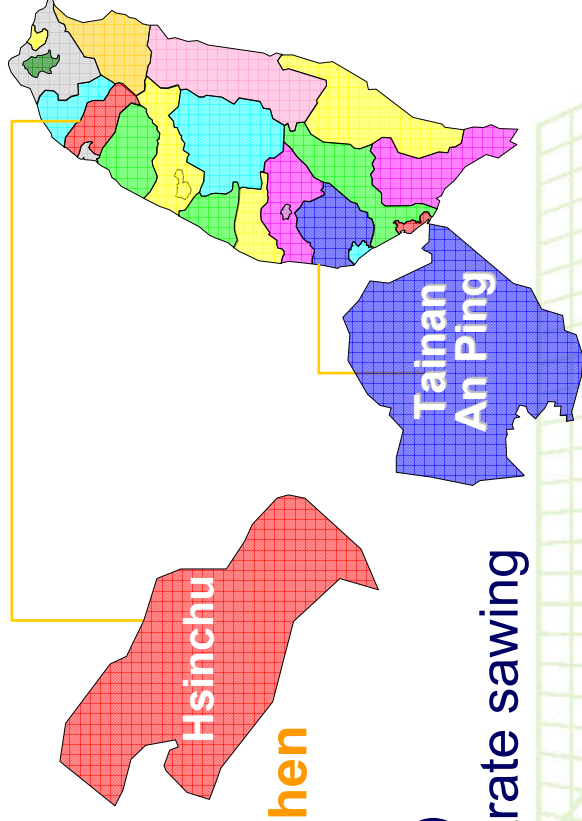

Factory Overview

Company Profile

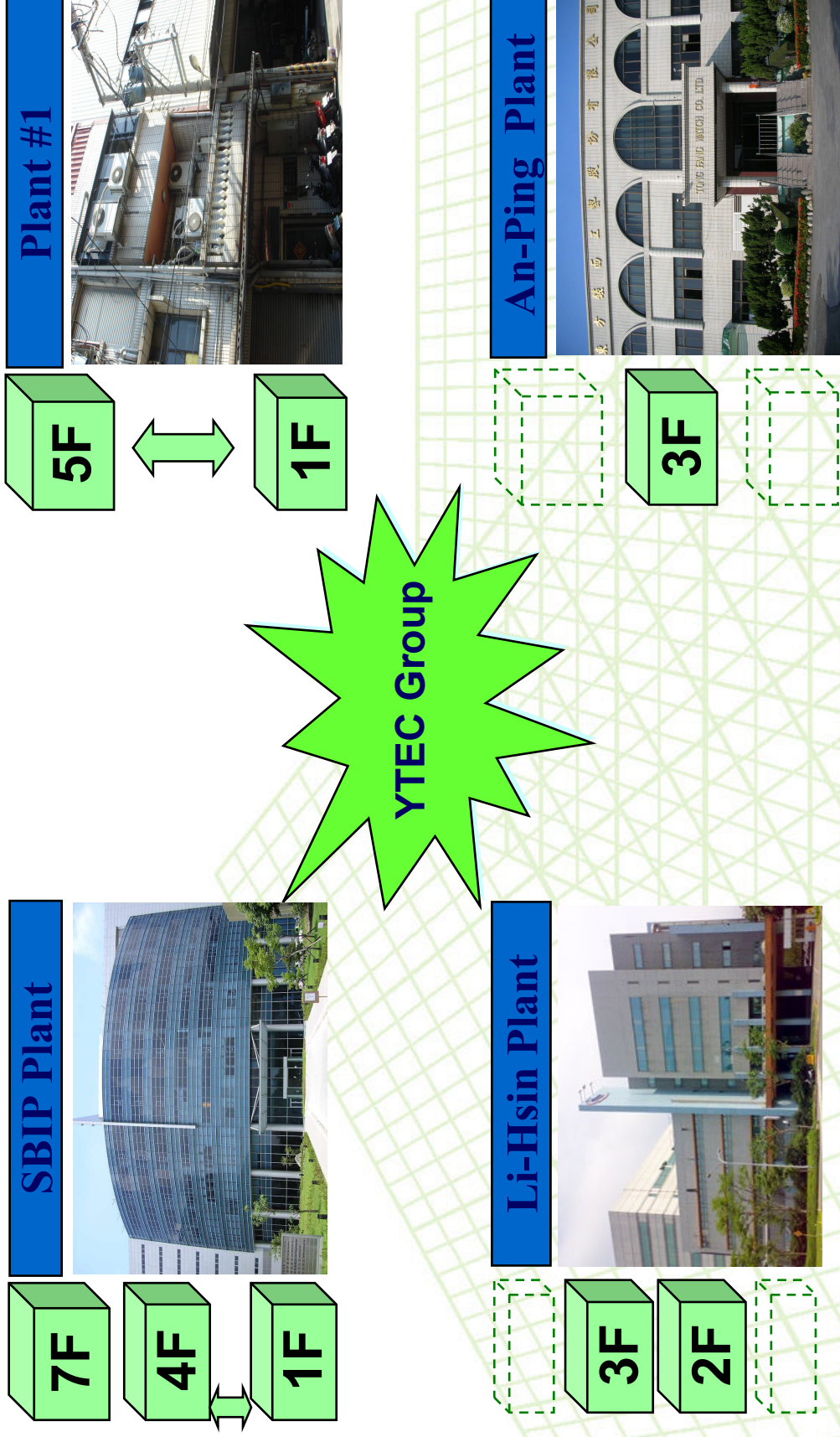

Company Milestone

Company Profile

- 1991/Jul. YTEC was founded and the capital is NTD \$ 5 million.
- 1998/Oct. Develop logic tester (Goblin) with 5 MHz/40 pins.
- 2000/Mar. Achieved the certification of ISO 9001
- 2000/Jul. Full-function IC tester was verified by industry agency with predominant product development project.
- 2002/Aug. SEC (Securities and Exchange Commission) approve YTEC to public stock.
- 2003/Nov. LED OEM service was established.
- 2003/Dec. Obtain OTC certification.
- 2004/Mar. Got the approval to establish the branch in Hsin chu SBIP.
- 2004/Mar.29 Listed in Taiwan stock exchange. (Stock No.: 6261)
- 2006/Dec. Achieved the certification of ISO 14001 and OHSAS 18001.
- 2007/Jul. Develop Tainan An Ping plant for LED sorting.
- 2007/Nov. Build up AOI key technologies and business.
- 2008/May Develop Li Hsin plant for LED test & sorting.
- 2008/Otc. Achieved the certification of ISO/TS 16949.
- 2009/Jun. Solar silicon substrate inspection system was verified by Science Park Administration with development project.
- 2010/Mar. Develop SBIP plant for wafer grinding & sawing.



Company Management Concept

Company Profile

經營理念：(Management Concept)

主人翁經營理念；下工程即是客戶。

Treat YTEC as your own company. (Host concept)

Treat all post projects and processes as our customers.

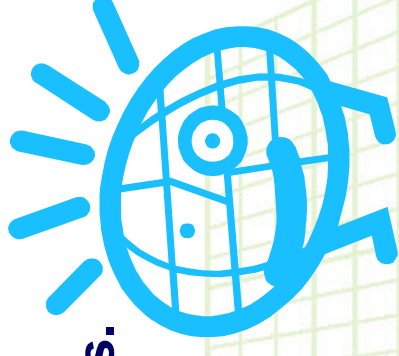

工作態度：(Working Attitude)

成功者找方法；失敗者找藉口。

A successful person will find the way to overcome a challenge

Loser finds excuses.



IC OEM Services

Company Profile

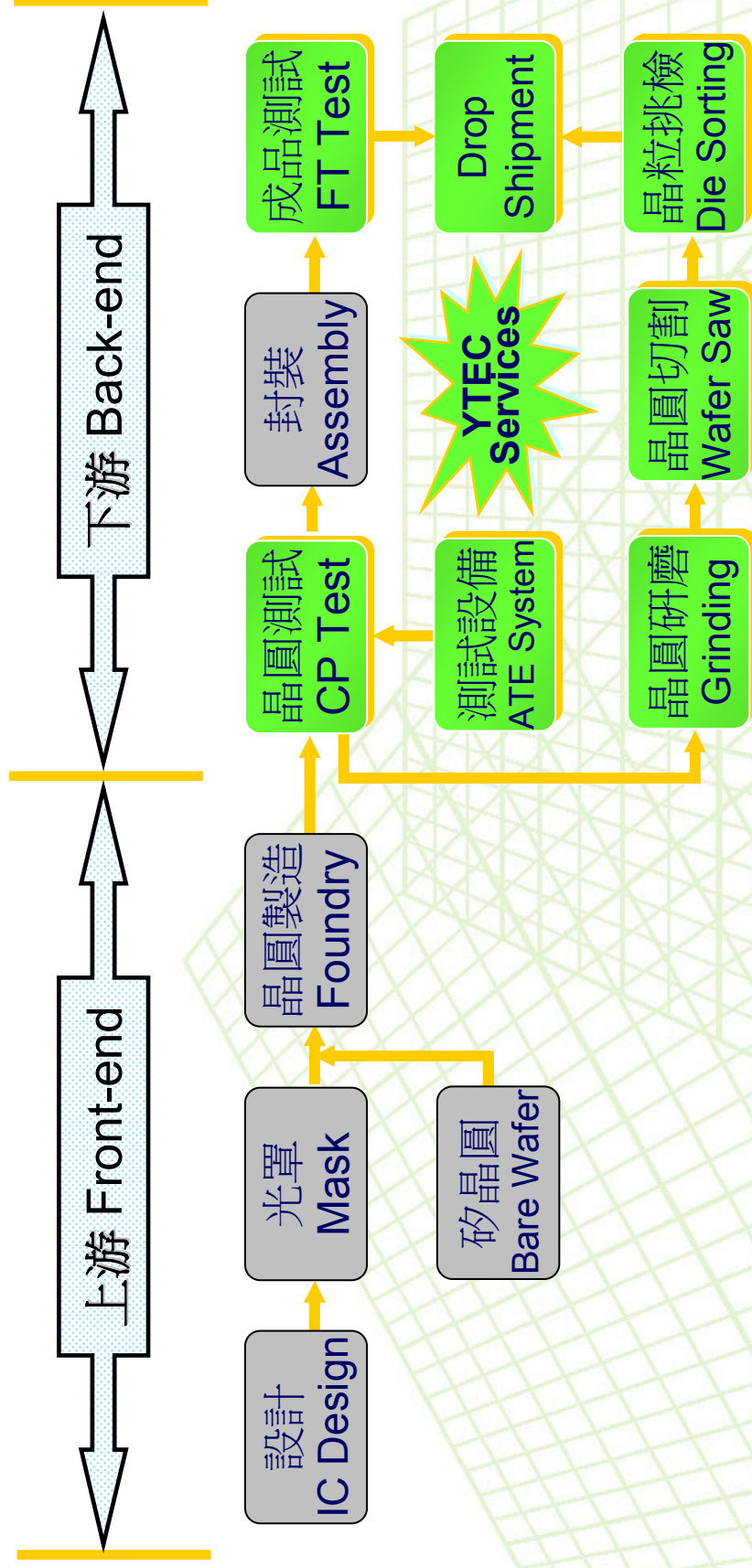

專業測試代工服務(IC Testing OEM)

Company Profile

- ❑ 4"~12" Wafer testing (CP)、Test program and test kit development (Probe-card design and manufacture).
- ❑ IC packaging testing (FT)、Package type : DIPs、T/SOPs、L/QFPs、QFN、L/BGA...
- ❑ PC peripheral product、Logic、Analog、Mixed-signal、No-volatile memory、MCU、LCD driver IC、High speed/ High pin count (Scud-1A 512C) testing.
- ❑ CIS(CMOS Image Sensor)、RF、SoC product testing
- ❑ Others : Laser trimming、Lead scanning、Test program and test kit development technical support **Turn-key service** (For example: PKG assembly、Tape-reel、Drop-shipment...).

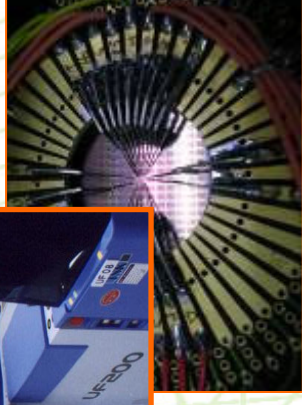
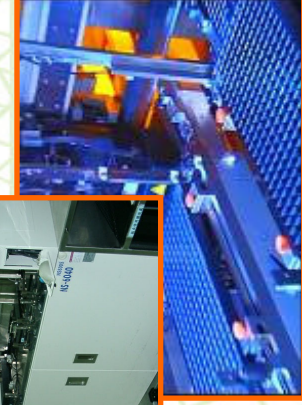
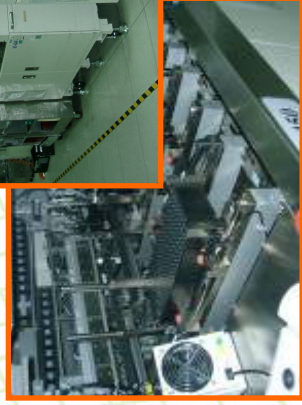
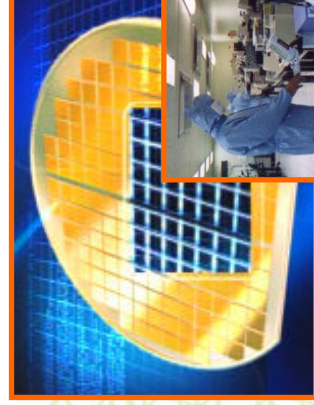
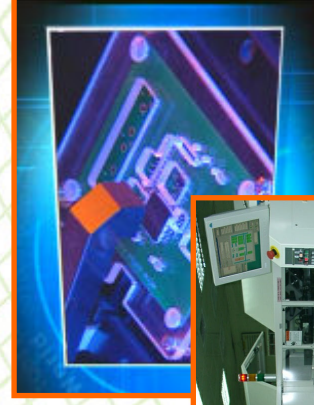
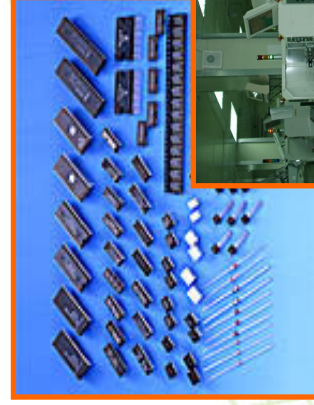

研磨、切割及挑檢代工服務

(Grinding, Sawing, P&P Service)

Company Profile

□ Service Items:

Wafer back-side grinding sawing chip pick & place services for Consumer and gold bump products.

Process	Back-side Grinding	Sawing	Pick & Place
Environment	 <p>Class 1K</p>	 <p>Class 1K</p>	 <p>Class 100</p>
Capability	<ul style="list-style-type: none"> ● 4"~12" Wafer Back-side Grinding ● 8"~12" Wafer Polish Solution ● Wafer TTV $\leq 5 \mu m$ ● Chip TTV $\leq 2 \mu m$ 	<ul style="list-style-type: none"> ● 4"~12" Wafer Sawing ● Dual Cutting Function ● High-pressure & Atomizing Cleaning System (二流體清洗裝置) ● Dust Collecting System 	<ul style="list-style-type: none"> ● 4"~12" Wafer Pick & Place ● Map and Ink Pick & Place Solution ● Chip Back-side AOI Inspection System



LED OEM Services

Company Profile

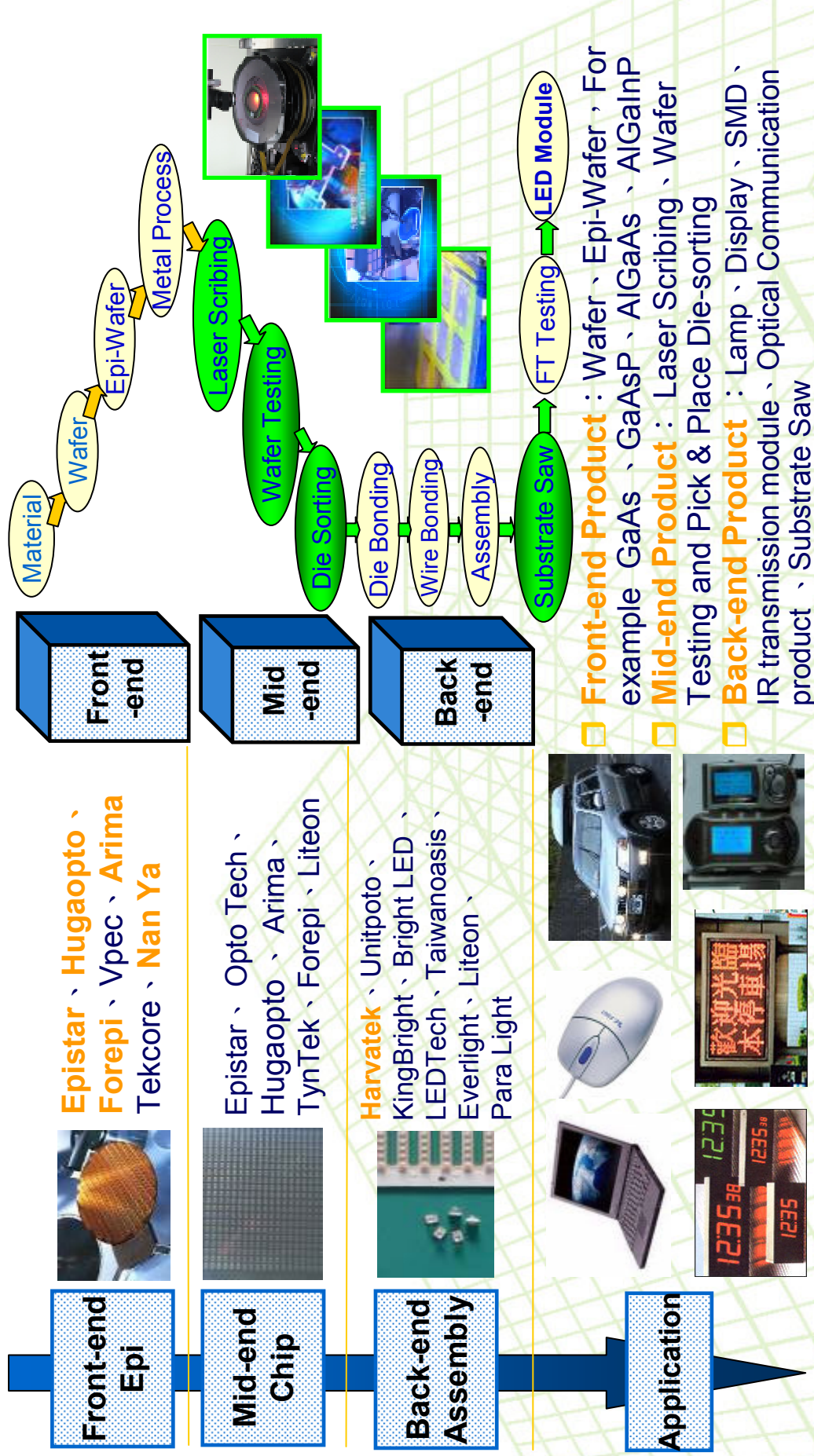

- **Front-end Product** : Wafer, Epi-Wafer, For example GaAs, GaAsP, AlGaAs, AlGaInP
- **Mid-end Product** : Laser Scribing, Wafer Testing and Pick & Place Die-sorting
- **Back-end Product** : Lamp, Display, SMD, IR transmission module, Optical Communication product, Substrate Saw



YoungTek Electronics Corp.

2009/2010 LED Sorting Output

Company Profile

Unit (KK)

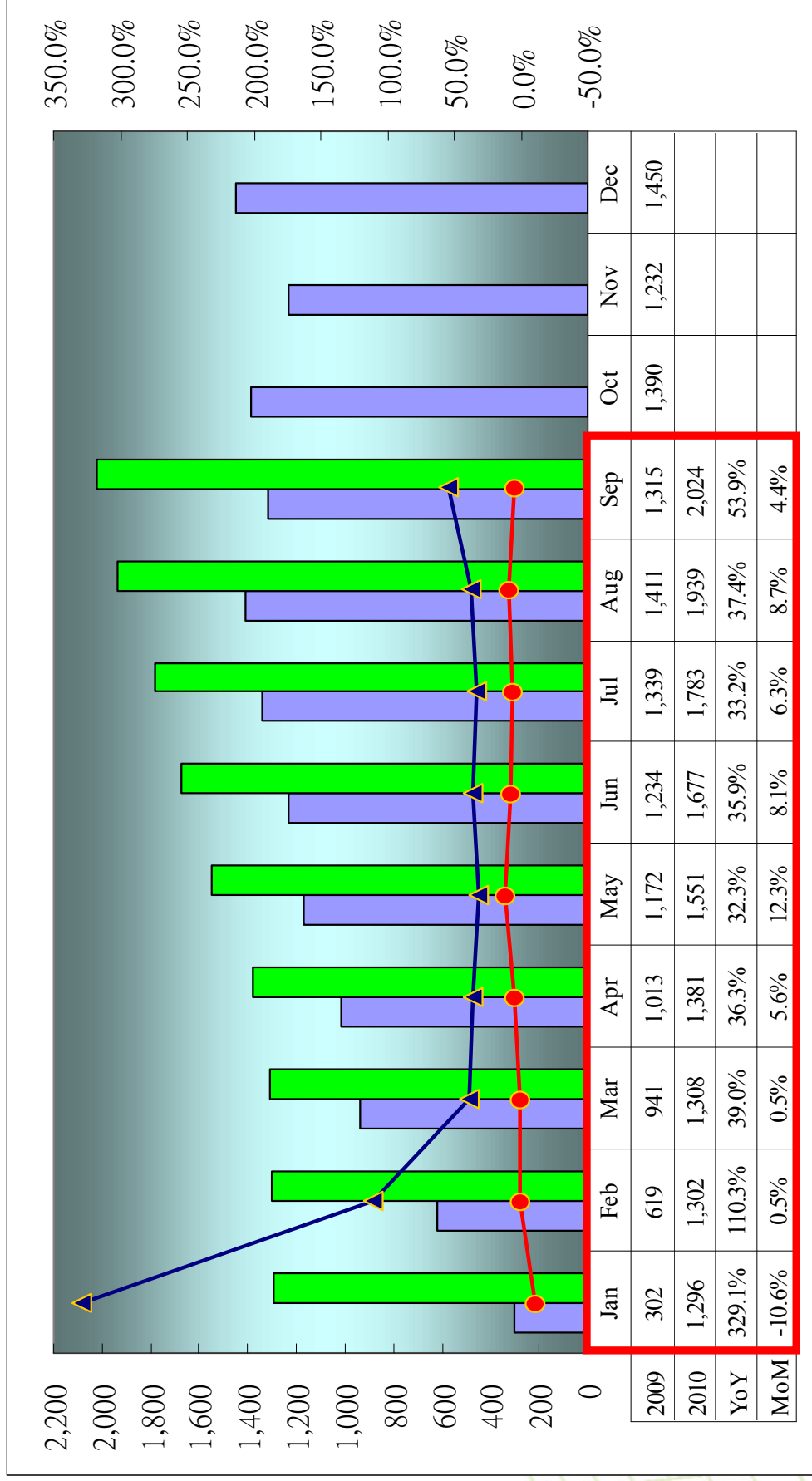



Own Product Development

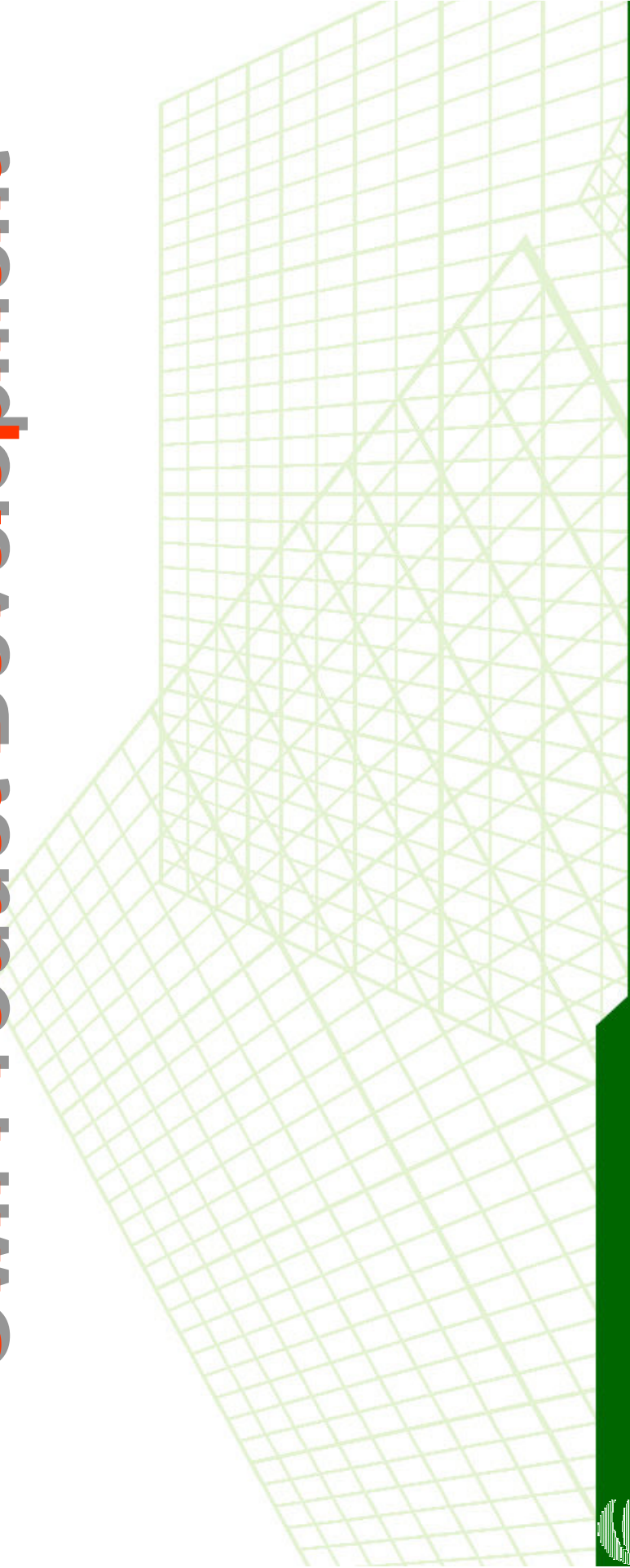

Own Product Development

Company Profile

- YT5100 High Speed SoC IC Tester
YT5100 全功能高速SoC IC測試機
- Scud-1A 512C full-function IC Tester
Scud-1A 512C 全功能 IC 測試機
- CIS(CMOS Image Sensor System)
CMOS影像感測系統
- HV LED Tester
全功能 LED 測試機



Own Product Development

Company Profile

□CCM (CMOS/Compact Camera Module)

影像感測模組測試設備

□AOI (Auto optical Inspection)

自動光學檢測系統

□YT2500 Multi Station Dual Feeding LED Dispenser

YT2500 多站雙軌 LED 點膠機

□YT6110 IC Test Handler

YT6110 IC 測試分類機



YT5100&Scud-1A IC Tester

Company Profile

YT5100 High Speed Soc IC Tester



Scud-1A Fully Auto IC Tester



YoungTek Electronics Corp.

CIS(CMOS Image Sensor) IC Tester

Company Profile

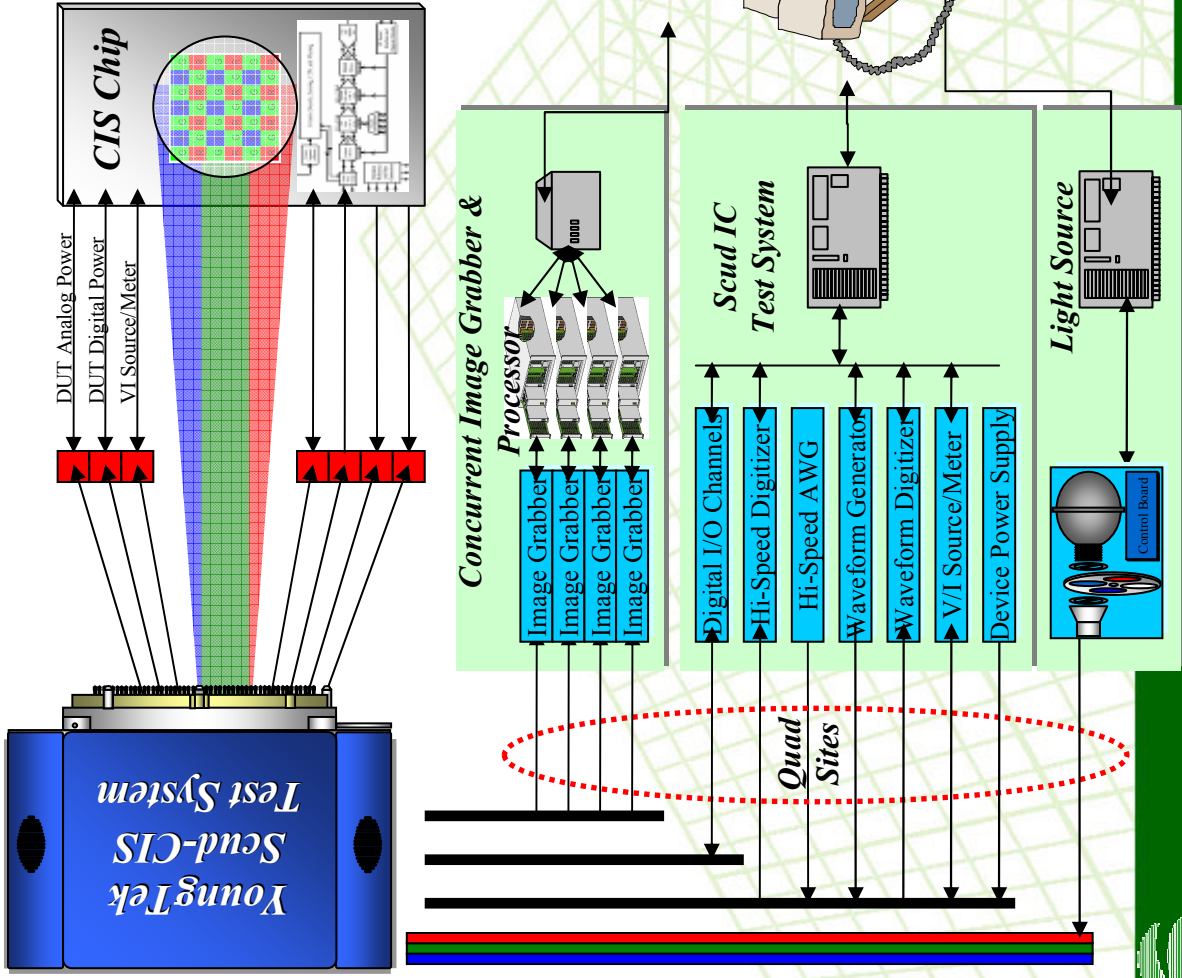

HV LED Tester

Company Profile

□ YTSD01 --> YTSD02 --> YTEC 8000 HV LED Tester

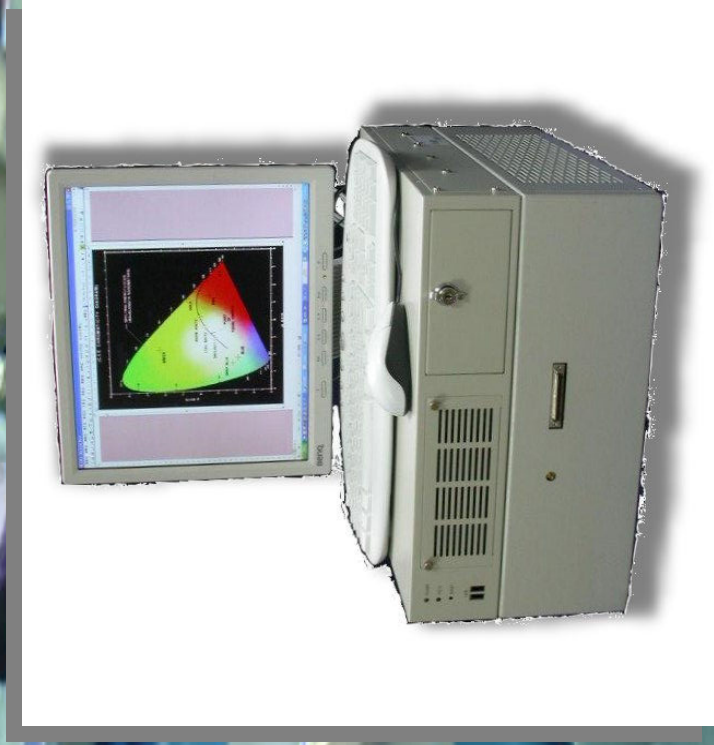

YoungTek Electronics Corp.

CCM(CMOS/Compact Camera Module)

Company Profile

CCM Test System YT3100

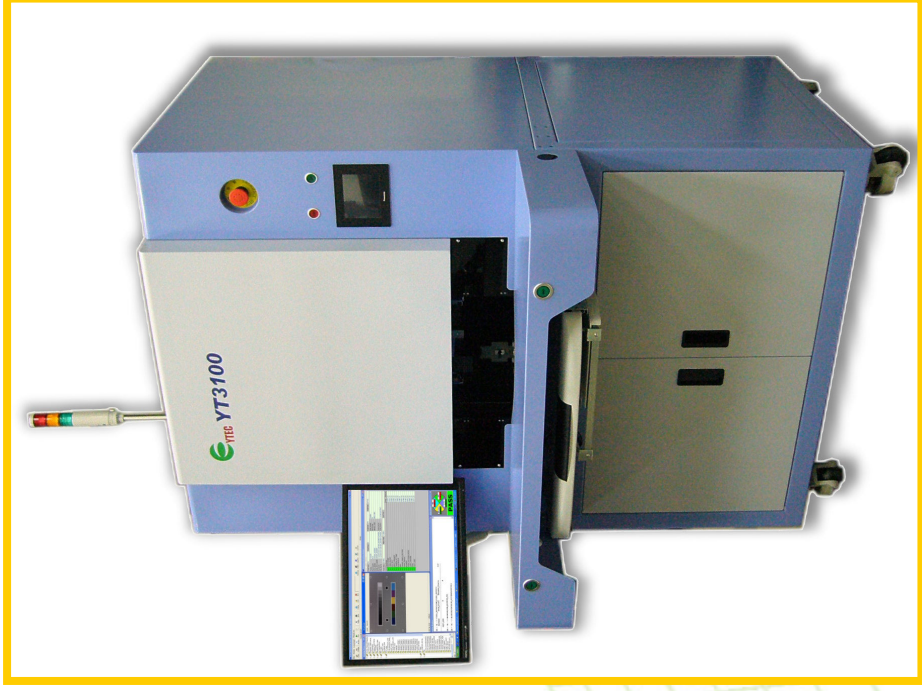

Fully Auto CCM Test System YT3300



CIS IC /CCM Application

Company Profile

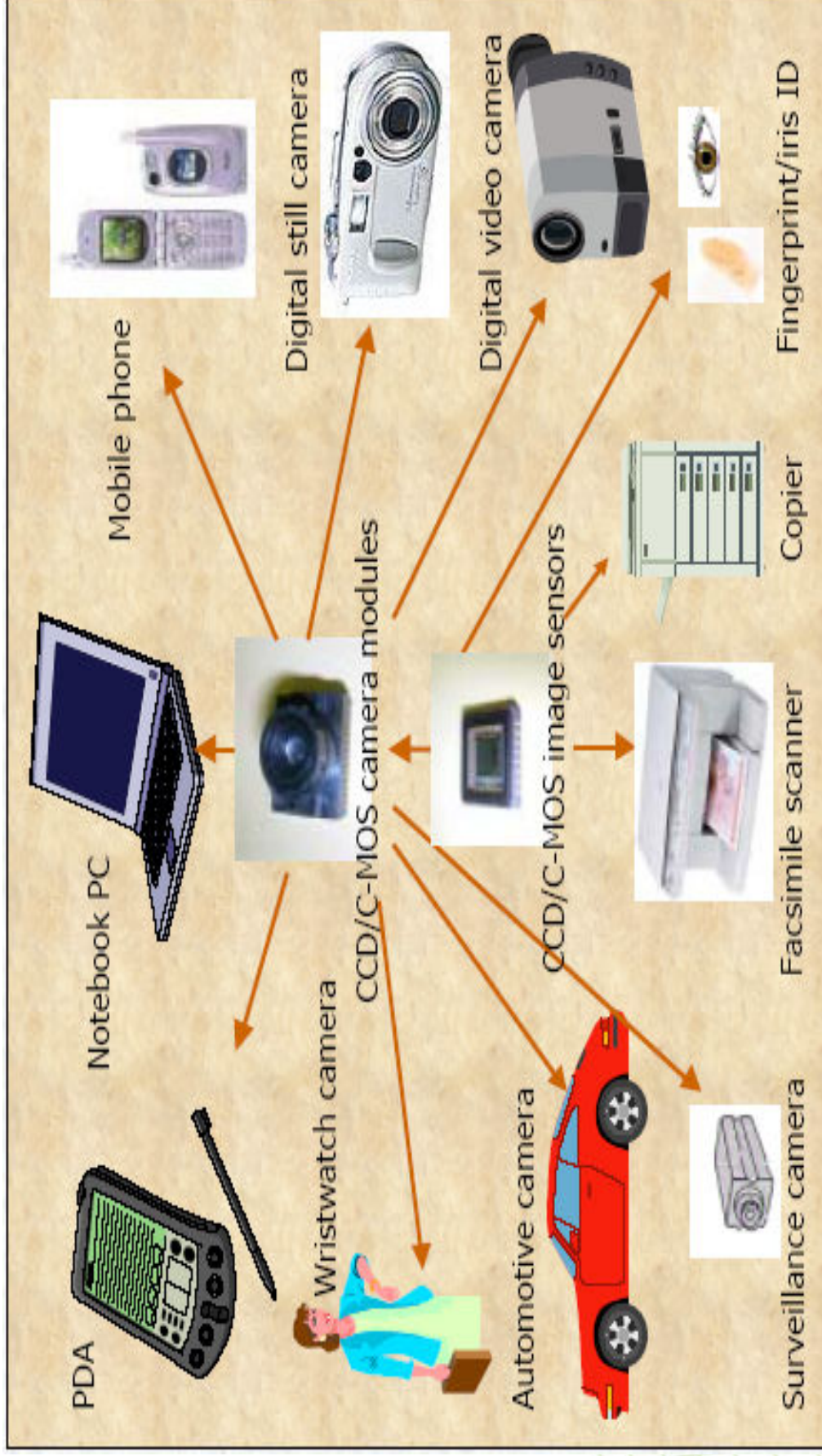

Consumer -, communication -, security management -, QA -, Automotive -, and Personal management tools...etc are using the CIS IC in our daily lives.



YoungTek Electronics Corp.

Auto Optical Inspection (自動光學檢測系統)

Company Profile

**YT 5311 LED Chip/Wafer/Mask
AOI System**

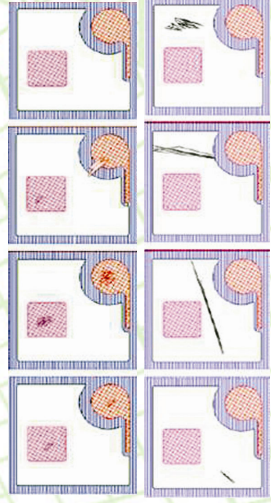

**YT 2800 LED Chip/Wafer/Mask
AOI System**

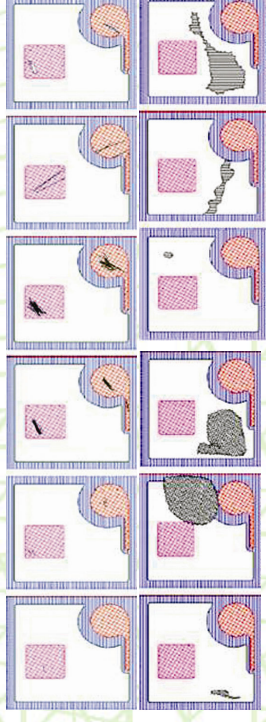

Auto Optical Inspection (自動光學檢測系統)

Company Profile

YT 2210 Reel Type Components AOI System

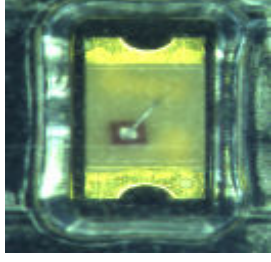

Polarity inverse package

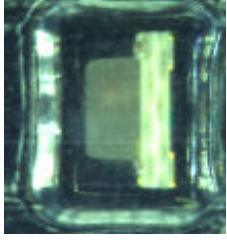

Tilt

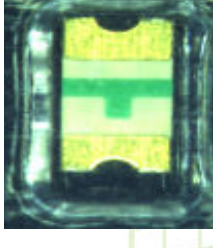

Over turn

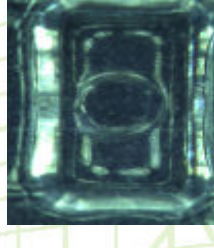

Empty

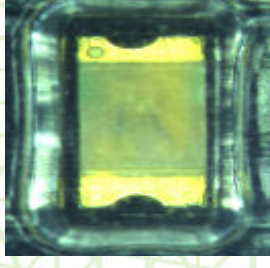

Mixed package

Auto Optical Inspection Application

Company Profile

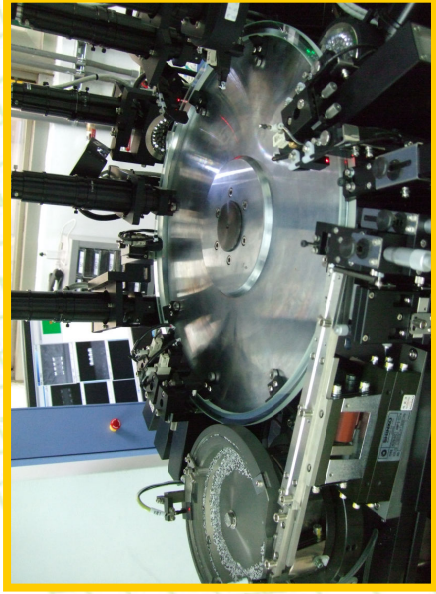
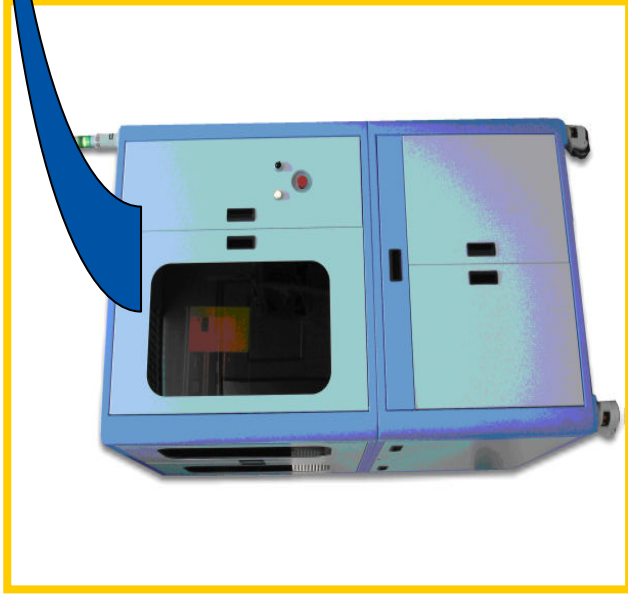

Reel type taped products:

- Resistor
- Capacitor
- Inductor
- LED
- IC
- Relay
- Connector
- Fuse



YT2500 LED Dispenser / YT6110 IC Test Handler

Company Profile

YT2500 LED Dispenser



YT6110 IC Test Handler



Promotion History

Company Profile



SEMICON® in Taiwan/China/Germany/USA 2001~2010

- ❑ 2001/09 Full function IC tester joined the SEMICON Taiwan 2001 Exhibition in Taipei
- ❑ 2002/03 Provided the SoC Test concept by joining the SEMICON China 2002 Exhibition in Shanghai
- ❑ 2002/04 Full function IC Tester joined the 1st Taiwan Semiconductor Equipment Exhibition
- ❑ 2002/09 Scud IC joined the SEMICON Taiwan 2002 Exhibition
- ❑ 2003/09 Scud-256C&512D IC joined the SEMICON Taiwan 2003 Exhibition
- ❑ 2004/03 IC test system joined the SEMICON China 2004 Exhibition in Shanghai
- ❑ 2004/09 Scud-1A & CIS IC tester joined the SEMICON Taiwan 2004 Exhibition
- ❑ 2005/03 IC test system joined the SEMICON China 2005 Exhibition in Shanghai
- ❑ 2005/03 GPS product joined the CeBIT show in Germany for European market promotion
- ❑ 2007/01 GPS product joined the CeBIT show in Las Vegas for U.S. and Global market promotion
- ❑ 2007/03 GPS product joined the CeBIT show in Germany for European market promotion.
- ❑ 2007/04 GPS product joined the Taipei vehicle uses the electronic exhibition
- ❑ 2008/06 AOI joined the OPTO Taiwan 2008 Exhibition in Taipei
- ❑ 2009/06 AOI joined the OPTO Taiwan 2009 Exhibition in Taipei
- ❑ 2009/09 AOI joined the OPTO China 2009 Exhibition in Shenzhen
- ❑ 2010/04 Joined the Foxconn Technology Corp. Quality Forum show
- ❑ 2010/09 AOI joined the OPTO China 2010 Exhibition in Shenzhen





Company Profile

Revenue Growth

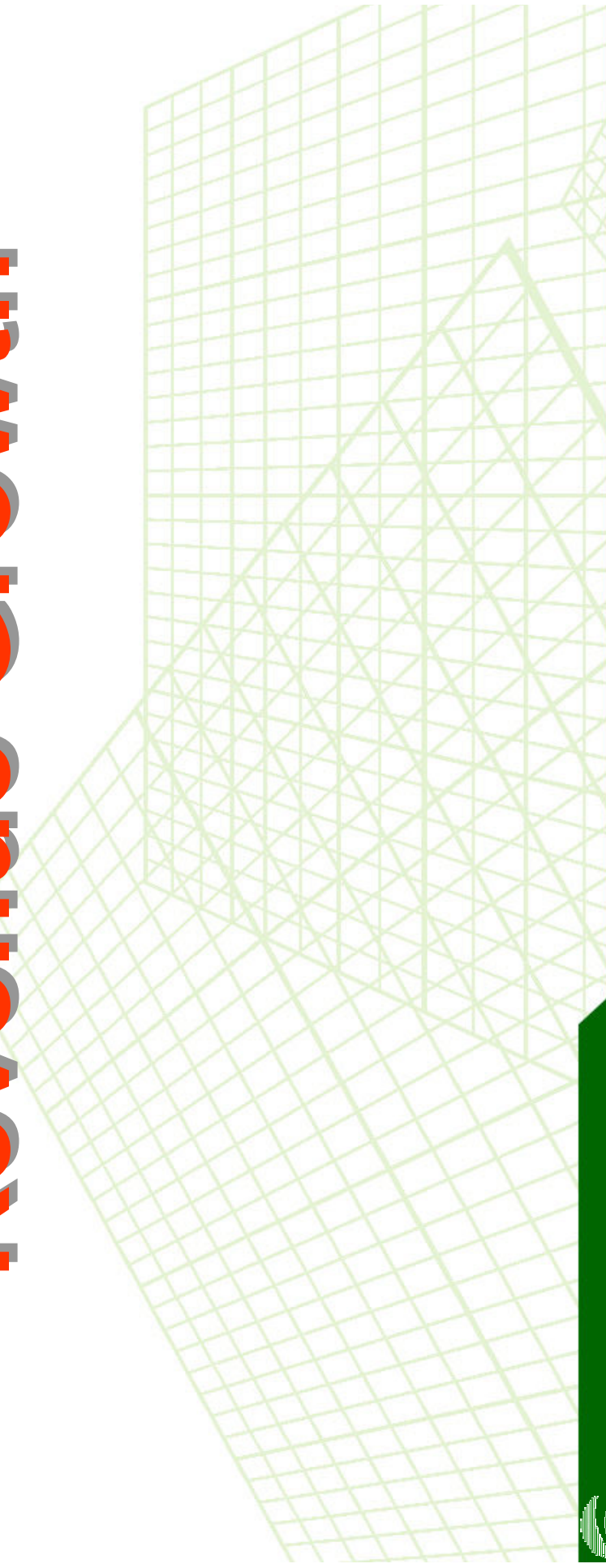

YoungTek Electronics Corp.

2009&2010 Monthly Revenue

Company Profile

NTS(Thousand)

Business Item/Month	Jan.	Feb.	Mar.	Apr.	May	Jun.	Jul.	Aug.	Sep.	Oct.	Nov.	Dec.	Total	Share(%)	
切磨拋檢代工 Sawing & Sorting OEM	2009	25,665	40,289	54,376	61,140	71,468	86,175	92,179	92,277	89,220	84,948	93,082	601,533	44.21%	
	2010	87,489	88,907	88,243	90,674	100,946	114,676	125,872	132,127				950,196	43.42%	
	YoY	240.89%	120.67%	62.28%	48.31%	41.25%	47.09%	40.72%	36.55%	43.19%				57.96%	
	MoM	-6.01%	1.62%	-0.75%	2.75%	11.33%	13.60%	5.74%	3.80%	4.97%					
測試代工 Testing OEM	2009	27,681	33,471	51,839	62,960	73,907	87,349	82,376	95,383	88,814	82,815	84,392	597,822	43.93%	
	2010	84,827	73,814	106,873	100,877	102,290	111,242	122,966	110,401				929,543	42.47%	
	YoY	206.44%	120.53%	106.16%	60.22%	38.40%	34.26%	33.09%	49.27%	15.74%			55.49%		
	MoM	0.52%	-12.98%	44.79%	-5.61%	1.40%	8.75%	4.50%	5.77%	-10.22%					
機器組裝等產品銷 售 Own Product Sales	2009	2,666	5,496	9,529	7,812	7,505	27,554	8,578	86,434	71,320	6,554	23,240	161,416	11.86%	
	2010	11,188	10,261	31,037	34,892	39,340	48,127	37,907	46,023				308,712	14.11%	
	YoY	319.65%	86.70%	225.71%	346.65%	424.18%	74.66%	548.87%	482.15%	-46.75%			91.25%		
	MoM	-51.86%	-8.29%	202.48%	12.42%	12.75%	22.34%	-21.24%	31.74%	-7.84%					
營業收入淨額 (Unit:K) Sales Revenue (Net)	2009	56,012	79,256	115,744	131,912	152,880	179,366	183,133	274,094	249,354	174,317	200,714	1,360,771	100.0%	
	2010	183,504	172,982	226,153	226,443	242,576	274,045	275,422	288,551				2,188,451	100.0%	
	YoY	227.62%	118.26%	95.39%	71.66%	58.67%	45.48%	53.55%	63.15%	5.27%			60.82%		
	MoM	-8.57%	-5.73%	30.74%	0.13%	7.12%	12.97%	0.50%	8.48%	-3.42%					
營業收入淨額 合計 Sales Revenue (Total)	2009	56,012	135,268	251,012	382,924	535,804	724,178	1,086,677	1,360,771	1,610,125	1,784,442	1,985,156	--	--	
	2010	183,504	356,486	582,639	809,082	1,051,658	1,325,703	1,601,125	2,188,451						
	YoY	227.62%	163.54%	132.12%	111.29%	96.28%	83.06%	77.20%	74.84%	60.82%					
	2009	53,346	73,760	106,215	124,100	145,375	160,820	173,524	174,555	187,660	178,034	167,763	177,474	1,199,355	--
總計代工成長 OEM Growth (Total)	2010	172,316	162,721	195,116	191,551	203,236	225,918	237,515	242,528				1,879,739		
	YoY	223.02%	120.61%	83.70%	54.35%	39.80%	40.48%	36.88%	42.56%	29.24%			56.73%		
	MoM	-2.91%	-5.57%	19.91%	-1.83%	6.10%	11.16%	5.13%	4.77%	-2.54%					



2001~2009 Revenue Growth

Company Profile

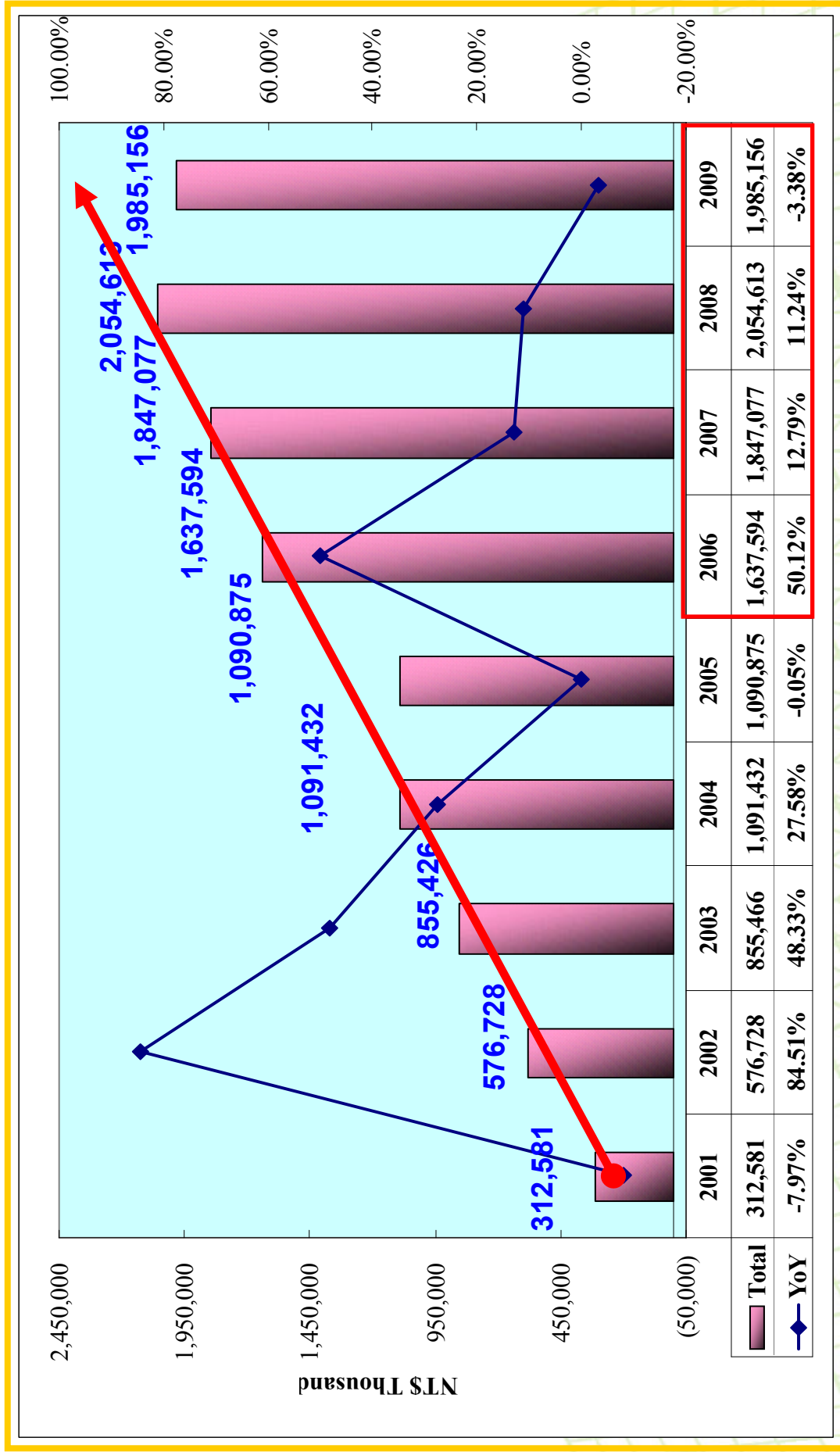

2001~2010 Operating Income

Company Profile

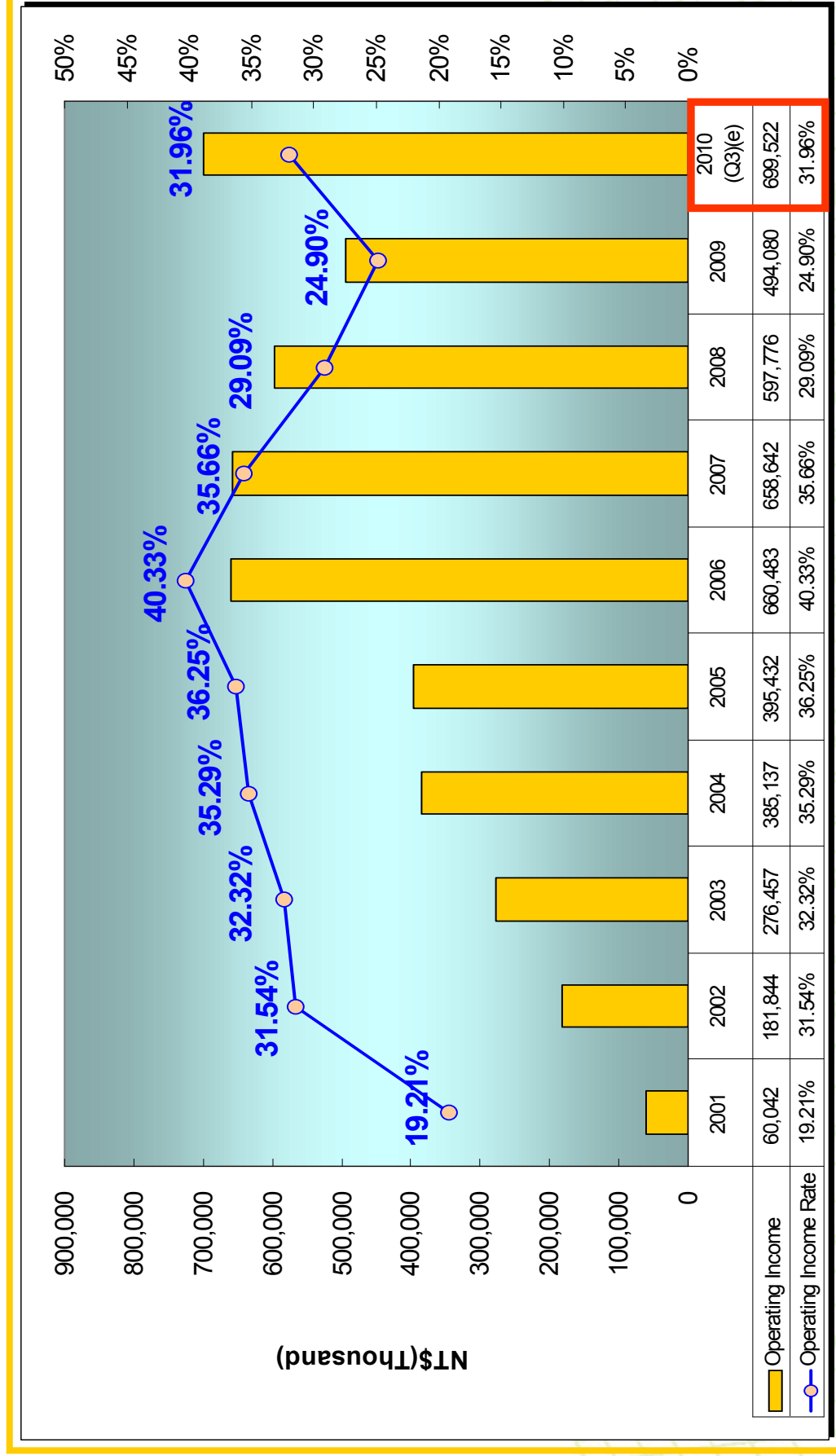

註：(e)表示預估值(estimate)。



2009/2010 Gross Profit

Company Profile

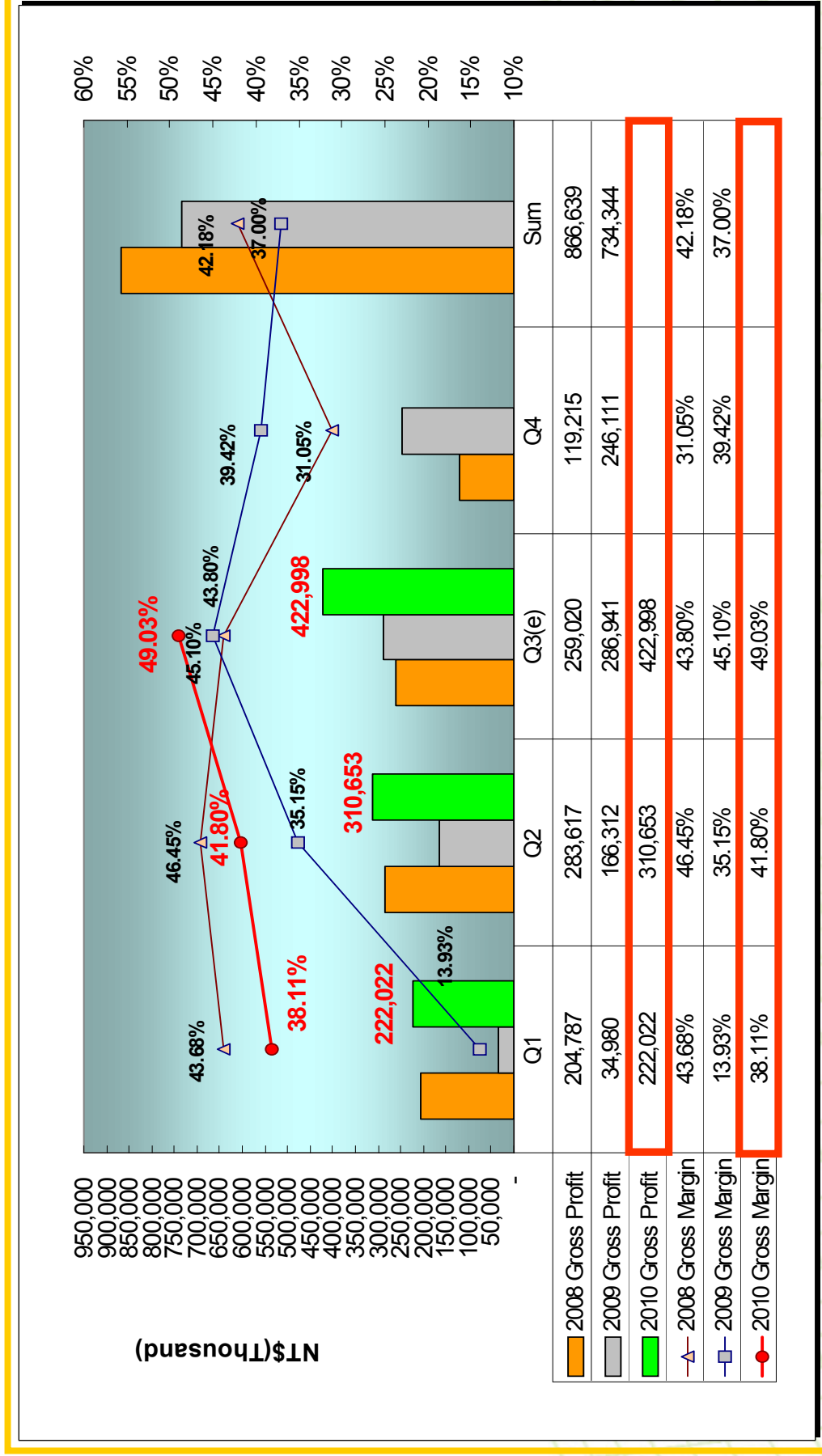

註：(e)表示預估值(estimate)。



Yearly Net Income & EPS

Company Profile

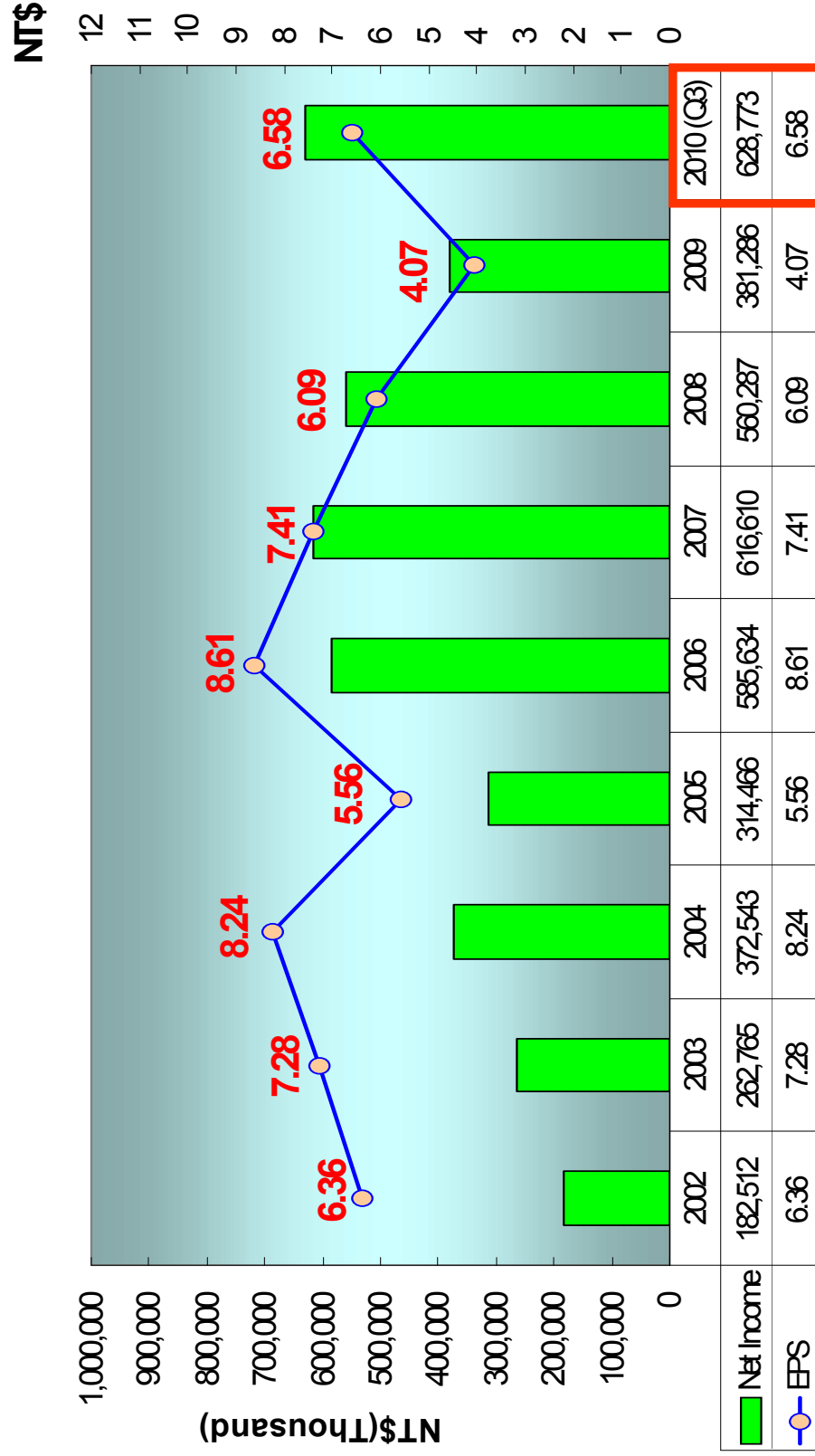

註：(e)表示預估值(estimate)。



YoungTek Electronics Corp.

Business Expansion Status (相關產業之狀況)

Company Profile

- 半導體及光電代工服務：2010年Q1業績YOY成長120%創歷史新高、Q2業績YOY成長45.5%、Q3YOY成長15.7%創歷史單季及上半年新高、進入九月份業績YOY成長43.2%、MOM成長5%創歷史單月新高、並連五月創新高現階段觀察客戶十月份LED需求、仍持續維持在高檔、因此將持續追蹤、另LED在新的應用提昇下樂觀預期在LED挑檢已擴充之產能應可適時提供市場成長之需求、相信可挹助公司之營收成長。
- IC測試系統開發：2006年3月份與美商安捷倫(Agilent)科技(新公司名稱: Verigy惠瑞捷)簽訂IC測試系統技術合作、除了2006年已陸續支付久元簽約金而達成階段性目標、因而提昇公司營收和獲利。另在雙方合作互動下已提昇測試機技術層次及銷售量、更上層樓。
- CIS、CCM及AOI設備開發：成功開發完成CIS(CMOS影像感測系統)、具備高速影像處理及完整電性測試之解決方案、並導入代工服務、挹助營收。另自行開發之CCM(影像感測模組測試設備)及AOI(自動光學檢測系統)等設備，目前已取得部份訂單且陸續交機中、AOI設備研發係以解決半導體及光電等產業在目檢之視覺盲點並可大幅節省人力、並已將光電技術結合影像分析等與自動化設備設計、成功研發出各類型外觀檢測機、在大環境逐漸回溫之際、2009年下半年起已感受到需求動力,統計機器組裝等產品銷售2009年YOY成長28.3%明顯高於預期、今2010年Q1業績YOY成長197%創歷史新高、Q2業績YOY成長185%創歷史單季新高、進入Q3業績YOY成長32.7%再創歷史單季新高、現階段觀察客戶狀況需求能見度至Q4、相信在持續開發新產品及功能提昇下、展望未來應可持續挹助業績成長之動力。
- 半導體代工服務：2010年Q1業績YOY成長135%、Q3YOY成長3.7%創歷史新高、Q2業績YOY成長43.1%、Q3YOY成長18.4%創歷史單季及上半年新高、進入Q3業績YOY成長31.9%、Q3YOY成長11.2%再創歷史單季新高、現階段觀察客戶十月份需求、將略低於9月、因此將持續追蹤、而YTEC在持續開發新產品與互補及平衡的產品線發酵下(如LCD,CIS.....etc)、展望未來應可持續挹助業績成長之動力。



Share payout composition and history

Company Profile

Year	九十二年度 (2003)	九十三年度 (2004)	九十四年度 (2005)	九十五年度 (2006)	九十六年度 (2007)	九十七年度 (2008)	九十八年度 (2009)	九十九年度 (2010)
	分派十一年 Profit(2002)	分派十二年 Profit(2003)	分派十三年 Profit(2004)	分派十四年 Profit(2005)	分派十五年 Profit(2006)	分派十六年 Profit(2007)	分派十七年 Profit(2008)	分派十八年 Profit(2009)
Cash(NID)	200	300	300	261	399	400	300	300
Free stock of	200	200	200	087	100	050	010	010
stock Capital reserve fund	-	-	-	-	-	-	-	-
ERS(NID)	636	728	824	556	861	741	609	407



Company competitive advantages

Company Profile

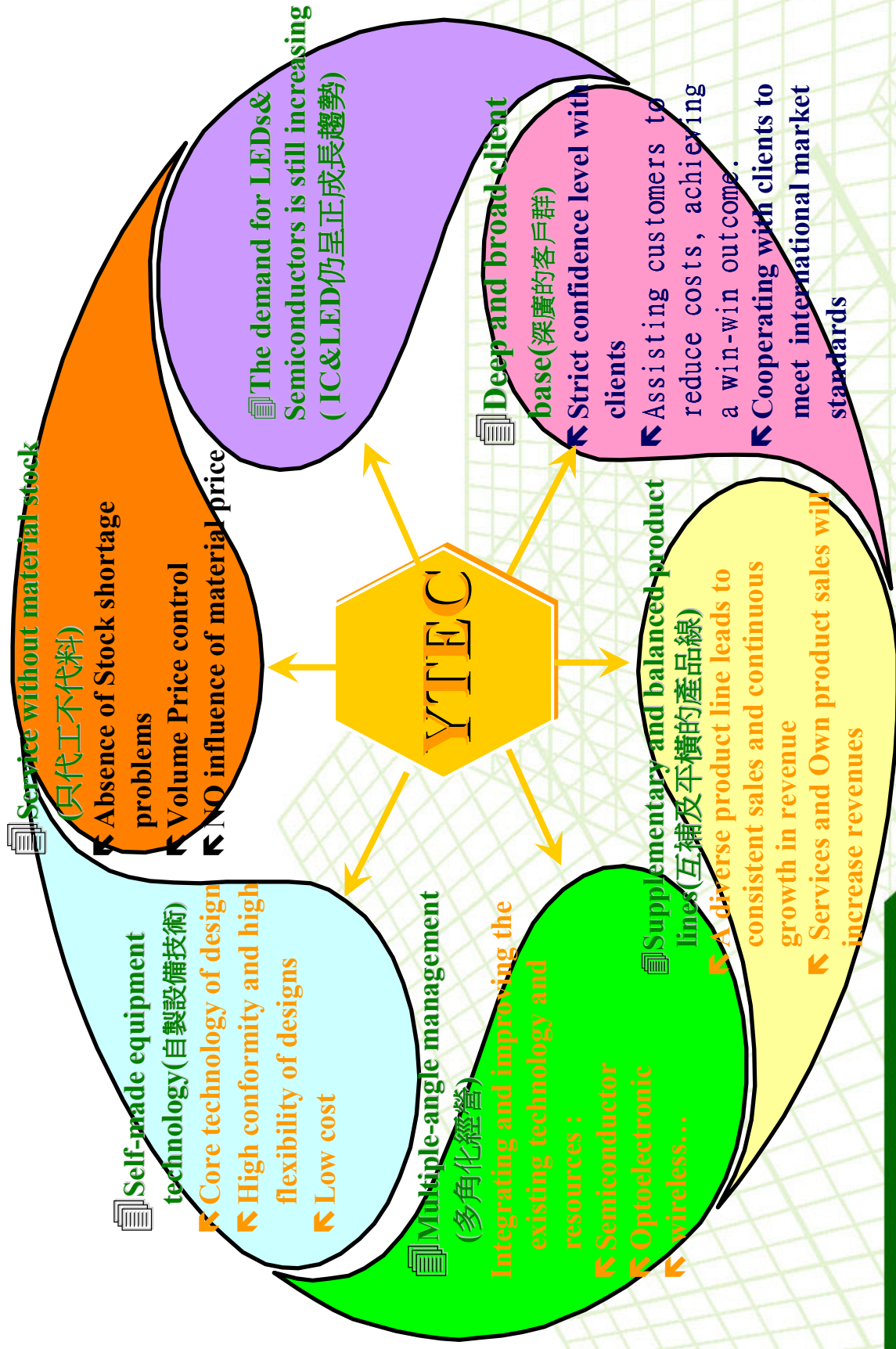

公司願景Company Mission

Company Profile

著眼於國內外市場的開拓，讓久元成爲立足台灣的整合性後段IC代工服務廠，並朝放眼世界的自有產品、自有品牌邁進。

Based on the domestic and international marketing development, YTEC has gotten a foothold as an integrated back-end IC OEM factory. YTEC moves forward, with it's own products, and Own Bench Marks.

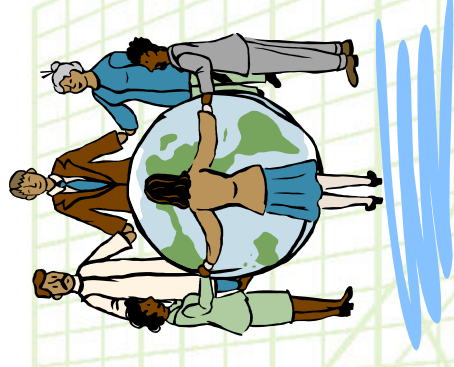

YoungTek Electronics Corp.

Q & A

Company Profile

Thank you very much



YoungTek Electronics Corp.