

Welcome

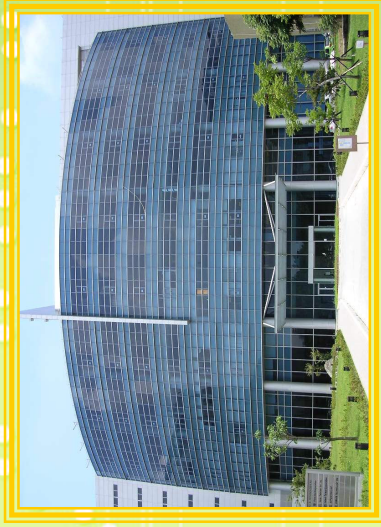

Welcome

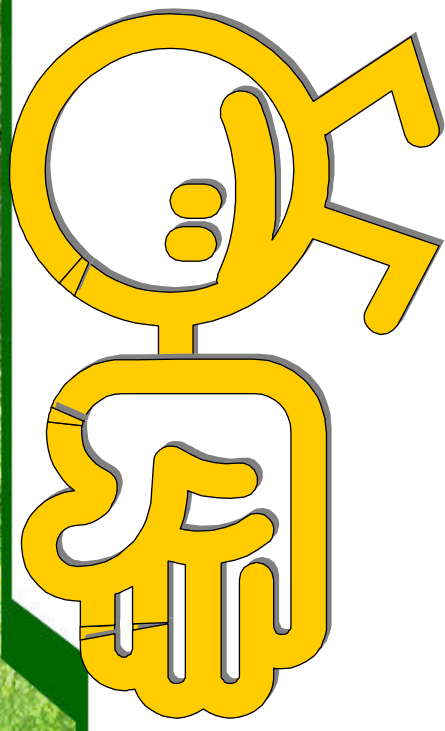

YoungTek Electronics Corp.

Stock No: 6261

Brief Introduction

Spokesman : Tony Liu
Date : 09 August, 2011

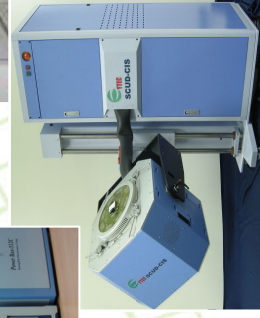

2011 VISIT SCHEDULE @久元

Company Profile

Contents

Time

- | | |
|---|-------------|
| <input type="checkbox"/> Brief Introduction of YTEC | 14:00~14:20 |
| <input type="checkbox"/> Q & A | 14:20~15:30 |
| <input type="checkbox"/> Line Tour (Free) | 15:30~16:00 |



YTEC YoungTek Electronics Corp.

Contents

Company Profile

- **Brief Introduction**
- **Factory Overview**
- **Company Milestone**
- **Company Management Concept**
- **OEM Services**
- **R&D Roadmap and Own Product Development**
- **Revenue Growth**
- **Company Mission**



YoungTek Electronics Corp.

Brief Introduction

Company Profile

Found Time : 1991/July

Chairman : Bily Wang

President of Service Group : Jeff Chang

President of Own Product Group : Glen Chen

Employees : 1086

Capital : NTD 1045 million (USD 36.2 million)

Address : Plant 1(1F~5F) : Special & substrate sawing

An Ping Plant (3F) : LED sorting & testing

Li Hsin Plant (2~3F、5~6F) : LED back-end turn-key service

SBIP Plant (1~4F、7F) : IC back-end turn-key service, ATE&AOI

Business Items :

- Semiconductor and LED OEMs**: Wafer sawing, grinding, sorting and IC testing, LED testing, laser scribing, sorting and substrate sawing.
- Design, manufacture and sales of semiconductor equipments**: CIS/CCM equipments, AOI system, full-function IC tester, logic IC tester, analog IC tester, Mixed-Signal IC Tester , LED tester, prober and sorter.

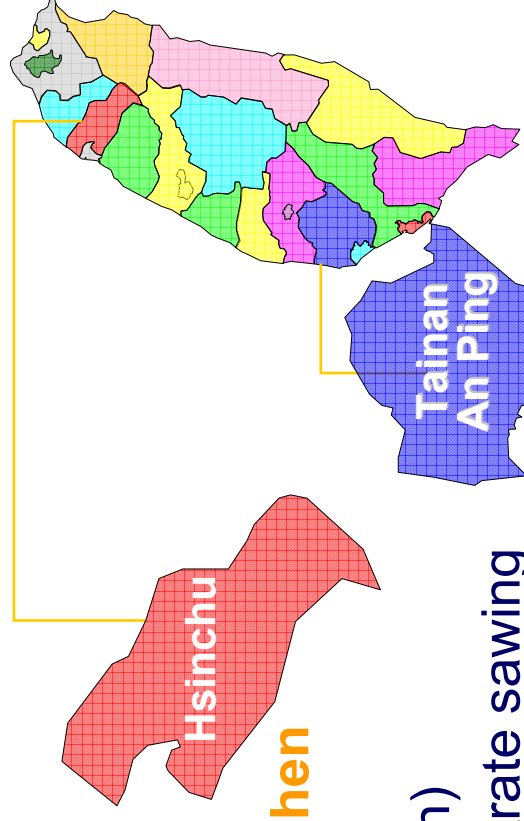

Factory Overview

Company Profile

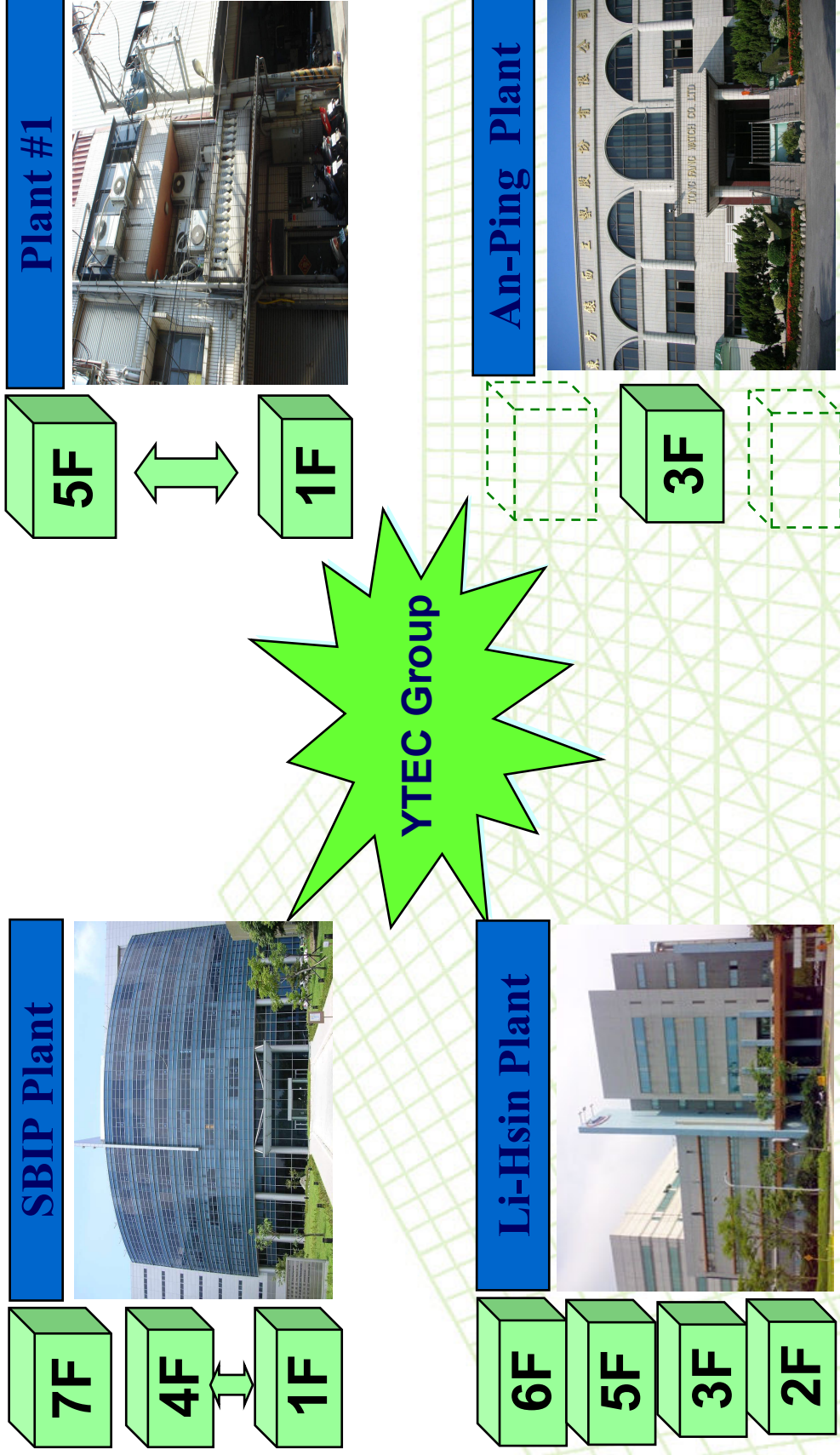

YoungTek Electronics Corp.

Company Milestone

Company Profile

- 1991/Jul. YTEC was founded and the capital is NTD \$ 5 million.
- 1998/Oct. Develop logic tester (Goblin) with 5 MHz/40 pins.
- 2000/Mar. Achieved the certification of ISO 9001
- 2000/Jul. Full-function IC tester was verified by industry agency with predominant product development project.
- 2002/Nov. SEC (Securities and Exchange Commission) approve YTEC to public stock.
- 2003/Nov. LED OEM service was established.
- 2003/Dec. Obtain OTC certification.
- 2004/Mar. Got the approval to establish the branch in Hsin chu SBIP.
- 2004/Mar.29 Listed in Taiwan stock exchange. (Stock No.: 6261)
- 2006/Dec. Achieved the certification of ISO 14001 and OHSAS 18001.
- 2007/Jul. Develop Tainan An Ping plant for LED sorting.
- 2007/Nov. Build up AOI key technologies and business.
- 2008/May Develop Li Hsin plant for LED test & sorting.
- 2008/Otc. Achieved the certification of ISO/TS 16949.
- 2009/Jun. Solar silicon substrate inspection system was verified by Science Park Administration with development project.
- 2010/Mar. Develop SBIP plant for wafer grinding & sawing.
- 2010/Otc. Achieved the certification of IECQ QC080000.



YTEC YoungTek Electronics Corp.

Company Management Concept

Company Profile

經營理念：(Management Concept)

主人翁經營理念；下工程即是客戶。

Treat YTEC as your own company. (Host concept)

Treat all post projects and processes as our customers.

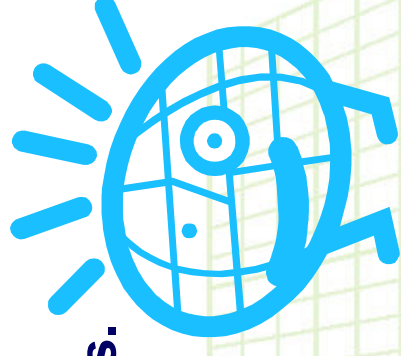

工作態度：(Working Attitude)

成功者找方法；失敗者找藉口。

A successful person will find the way to overcome a challenge

Loser finds excuses.



YTEC YoungTek Electronics Corp.

IC OEM Services

Company Profile

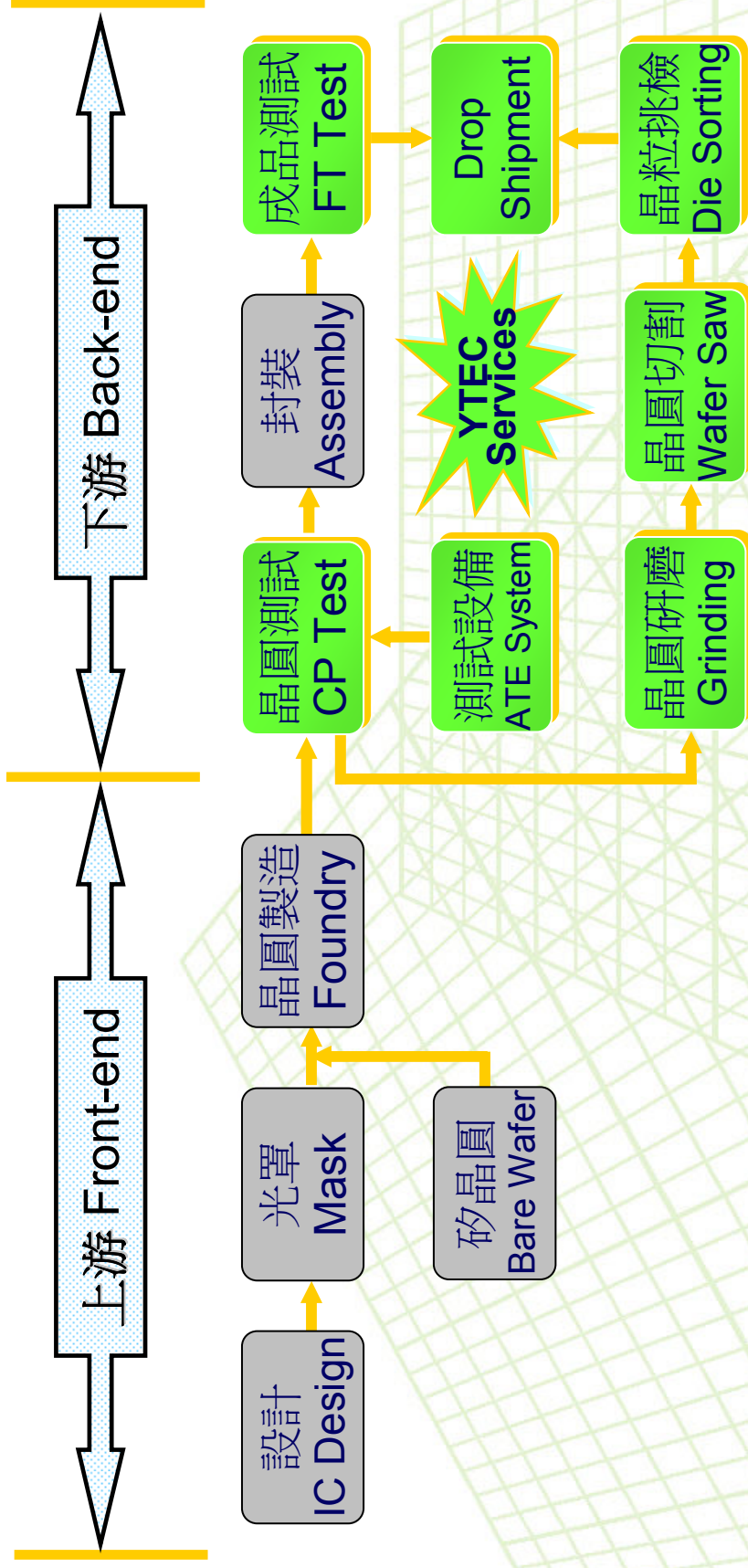

YTEC YoungTek Electronics Corp.

專業測試代工服務(IC Testing OEM)

Company Profile

- ❑ 4"~12" Wafer testing (CP)、Test program and test kit development (Probe-card design and manufacture).
- ❑ IC packaging testing (FT)、Package type : DIPs、T/SOPs、L/QFPs、QFN、L/BGA...
- ❑ PC peripheral product、Logic、Analog、Mixed-signal、No-volatile memory、MCU、LCD driver IC、High speed/ High pin count (Scud-1A 512C) testing.
- ❑ CIS(CMOS Image Sensor)、RF、SoC product testing
- ❑ Others : Laser trimming、Lead scanning、Test program and test kit development technical support **Turn-key service** (For example: PKG assembly、Tape-reel、Drop-shipment...).

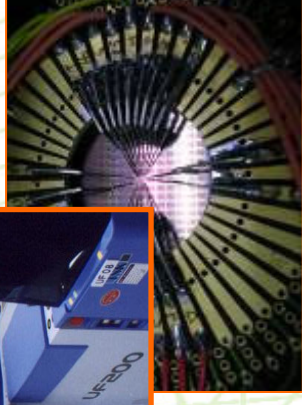
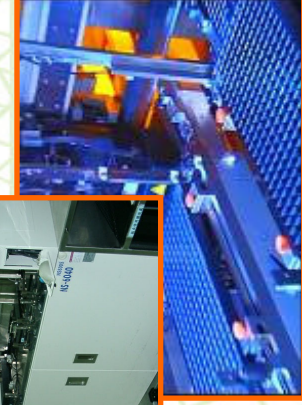
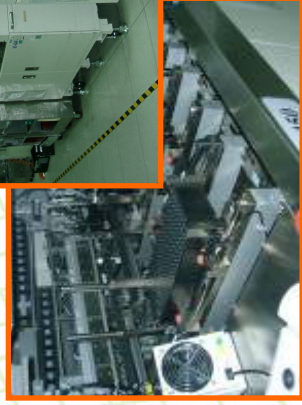
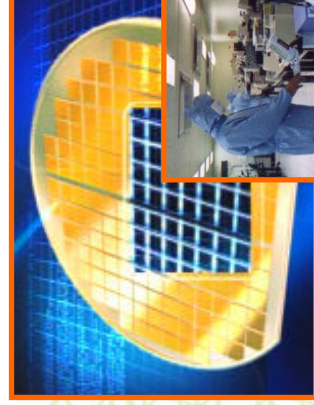
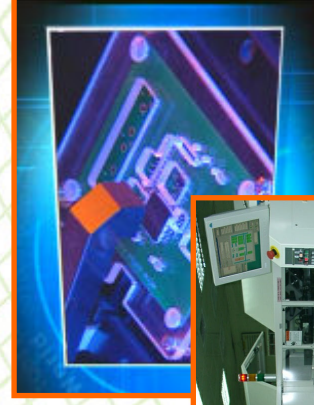
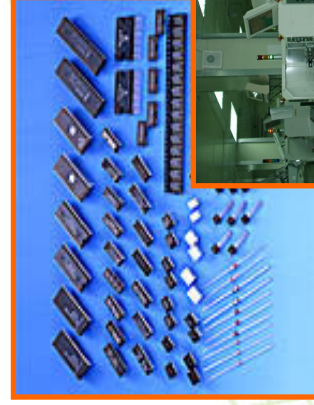

研磨、切割及挑檢代工服務

(Grinding, Sawing, P&P Service)

Company Profile

□ Service Items:

Wafer back-side grinding **sawing** **chip pick & place** services for Consumer and gold bump products.

Process	Back-side Grinding	Sawing	Pick & Place
Environment	 Class 1K	 Class 1K	 Class 100
Capability	<ul style="list-style-type: none">● 4"~12" Wafer● Back-side Grinding● 8"~12" Wafer● Polish Solution● Wafer TTV $\leq 5 \mu m$● Chip TTV $\leq 2 \mu m$	<ul style="list-style-type: none">● 4"~12" Wafer Sawing● Dual Cutting Function● High-pressure & Atomizing Cleaning System (二流體清洗裝置)● Dust Collecting System	<ul style="list-style-type: none">● 4"~12" Wafer Pick & Place● Map and Ink● Pick & Place Solution● Chip Back-side AOI Inspection System



YoungTek Electronics Corp.

LED OEM Services

Company Profile

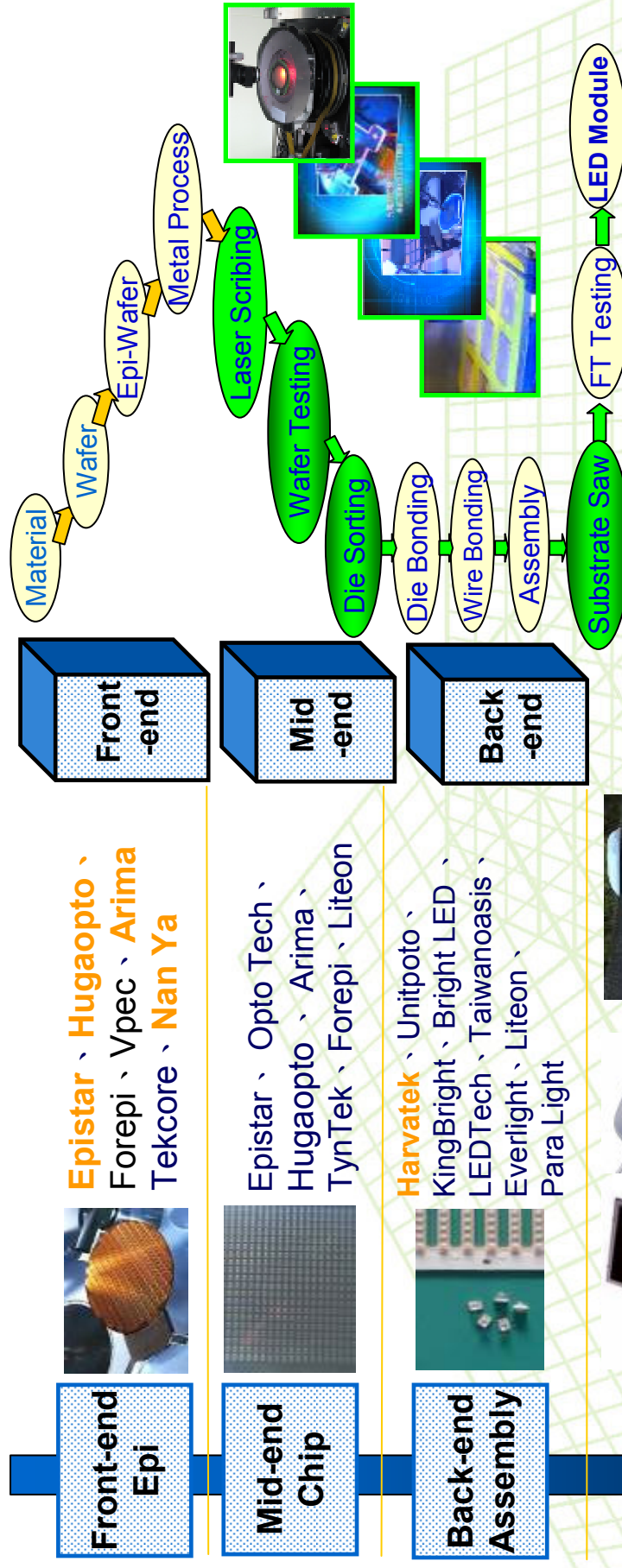

- **Front-end Product** : Wafer, Epi-Wafer, For example GaAs, GaAsP, AlGaAs, AlGaInP
- **Mid-end Product** : Laser Scribing, Wafer Testing and Pick & Place Die-sorting
- **Back-end Product** : Lamp, Display, SMD, IR transmission module, Optical Communication product, Substrate Saw



YoungTek Electronics Corp.



Company Profile

Own Product Development

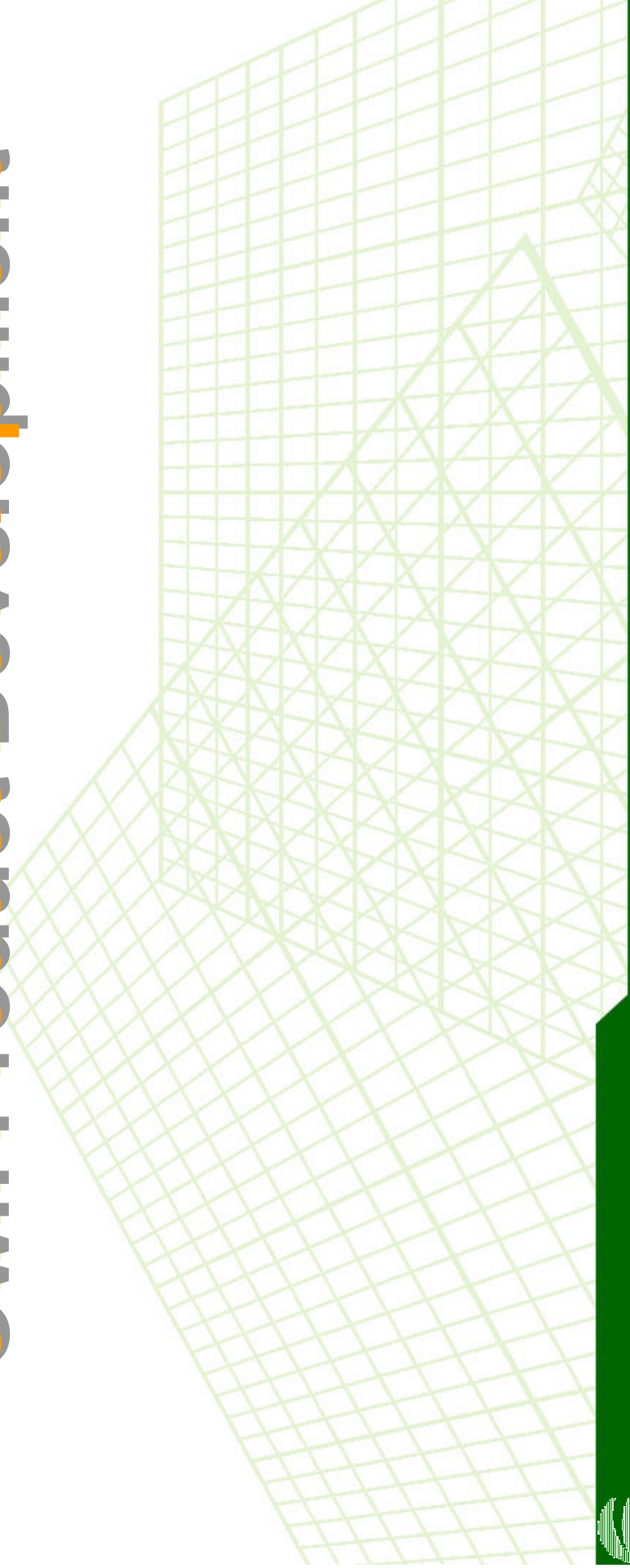

YTEC YoungTek Electronics Corp.

Own Product Development

Company Profile

- YT5100 High Speed SOC IC Tester
YT5100 全功能高速SOC IC測試機
- Scud-1A 512C full-function IC Tester
Scud-1A 512C 全功能 IC 測試機
- CIS(CMOS Image Sensor System)
CMOS影像感測系統
- HV LED Tester
全功能 LED 測試機



YoungTek Electronics Corp.

Own Product Development

Company Profile

□CCM (CMOS/Compact Camera Module)

影像感測模組測試設備

□AOI (Auto optical Inspection)

自動光學檢測系統

□YT2500 Multi Station Dual Feeding LED Dispenser

YT2500 多站雙軌 LED 點膠機

□YT6110 IC Test Handler

YT6110 IC 測試分類機



YoungTek Electronics Corp.

YT5100&Scud-1A IC Tester

Company Profile

YT5100 High Speed Soc IC Tester



Scud-1A Fully Auto IC Tester



Scud-1A IC Tester System Environment

Company Profile

The screenshots illustrate the following components of the Scud-1A IC Tester System Environment:

- TEST PROGRAM ZIP2:** A window for loading and configuring test programs, including fields for PGM, PGM, and PGM.
- TEST PROGRAM:** A window displaying the loaded test program, showing a list of test items and their parameters.
- TEST RESULT:** A window showing the test results, including a grid of test results and a summary table.
- TEST LOG:** A window displaying the test log, showing the test process and any errors or warnings.
- TEST RESULT TABLE:** A table showing the test results for various test items, including columns for Test No., Test Name, Test Result, and Test Date.

YoungTek Electronics Corp.



CIS(CMOS Image Sensor) IC Tester

Company Profile

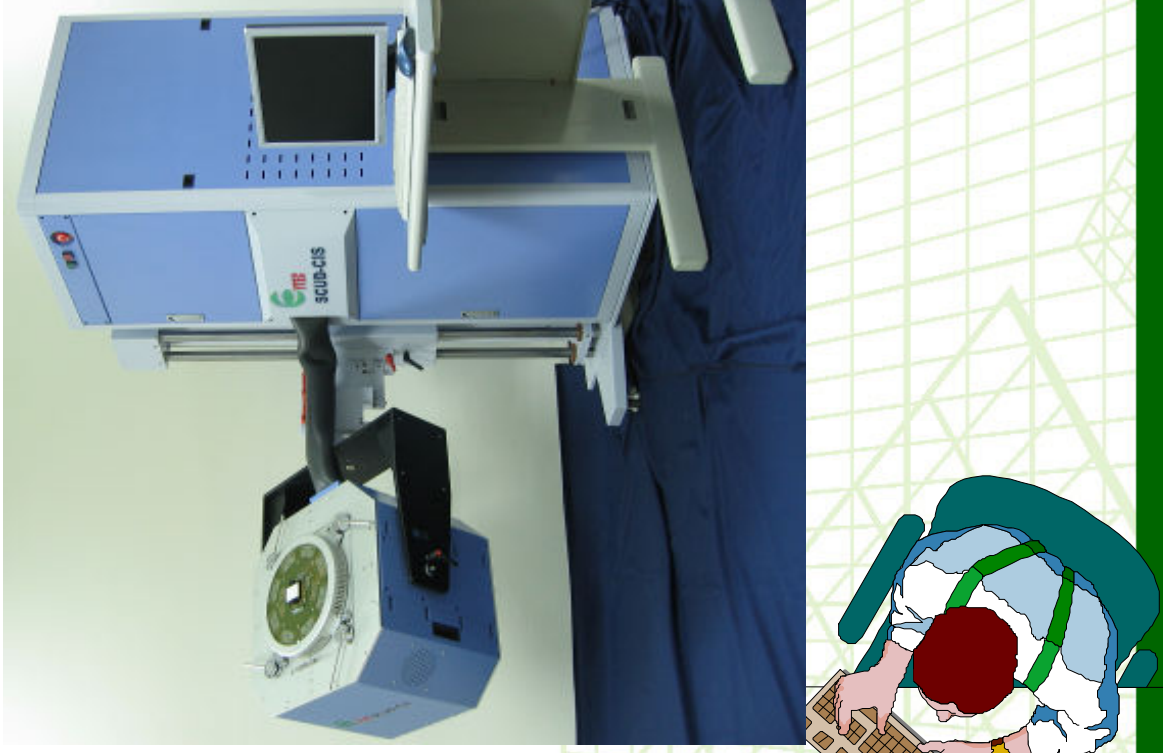
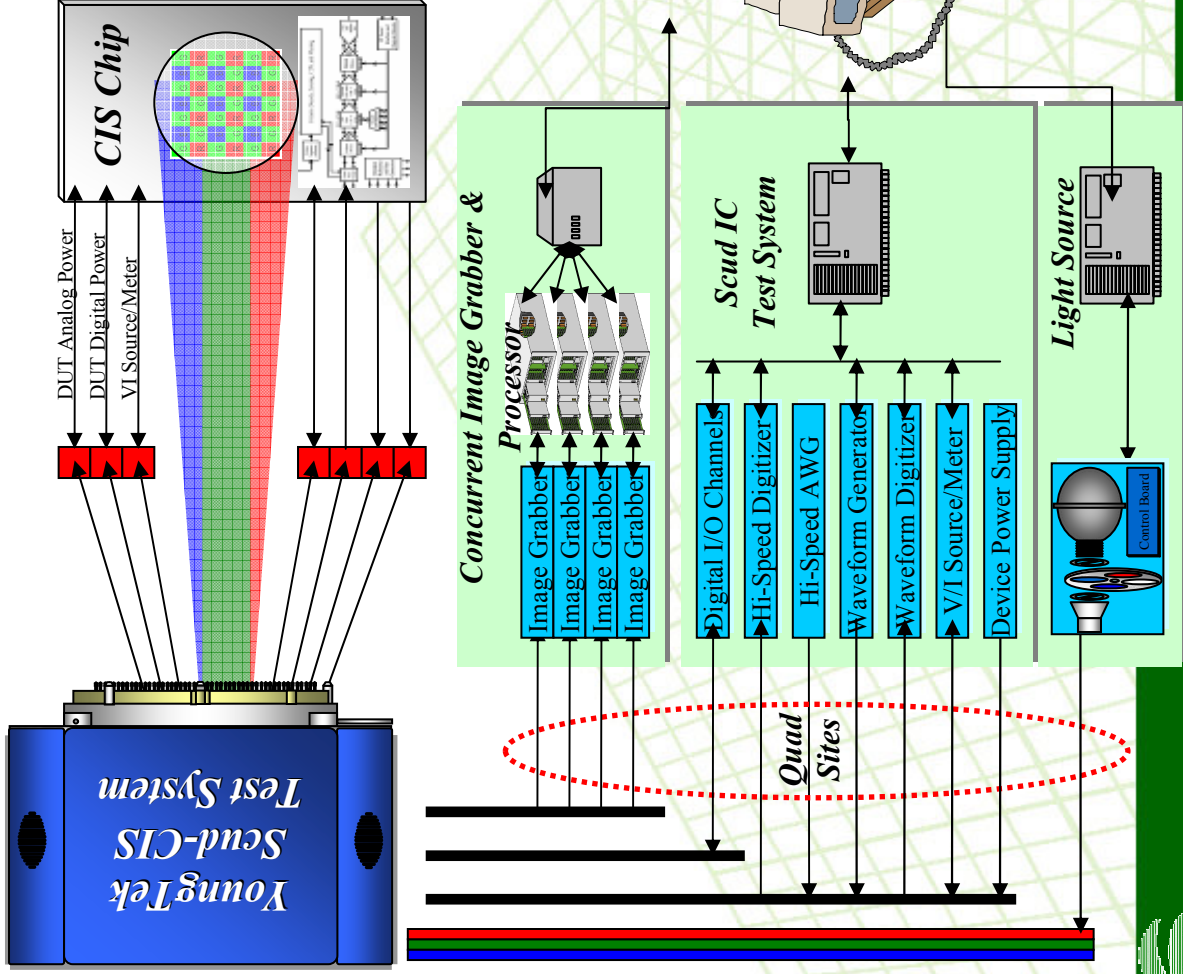

YT1100 LED Tester(YT1100 LED 測試機)

Company Profile

- YTSD01 -> YTSD02 -> YT1000 HV LED Tester(8000V ESD)
- > YT1100 HV LED Tester (Multi-station)

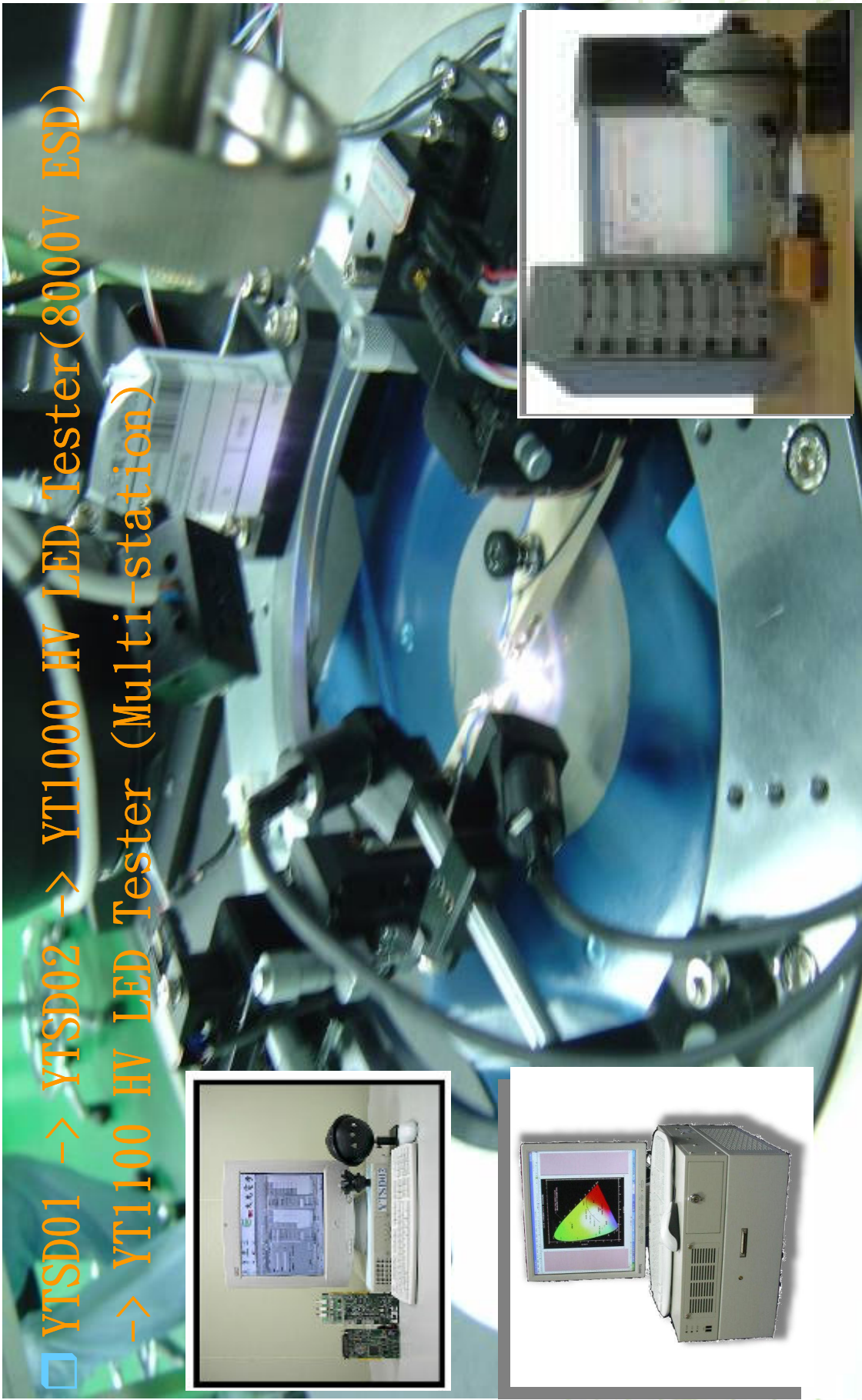

YoungTek Electronics Corp.

CCM(CMOS/Compact Camera Module)

Company Profile

CCM Test System YT3100



Fully Auto CCM Test System YT3300

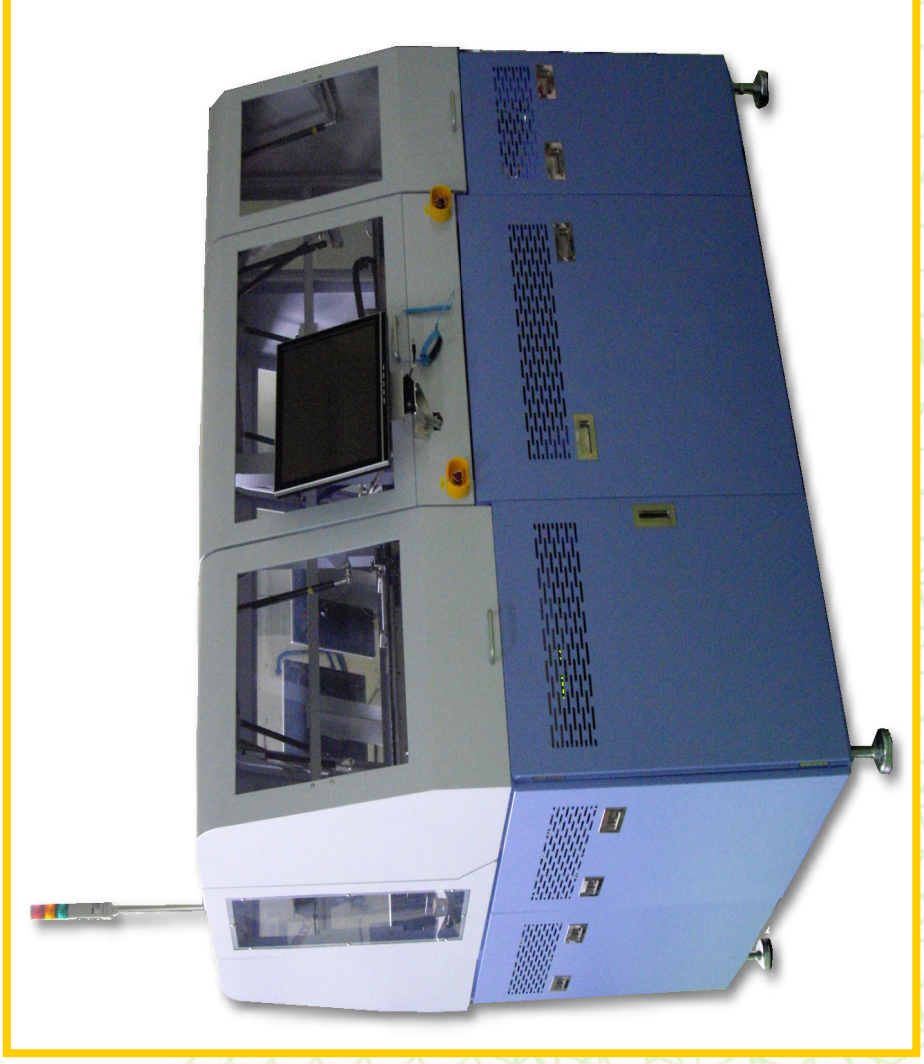

Auto Optical Inspection (自動光學檢測系統)

Company Profile

**YT 5311 LED Chip/Wafer/Mask
AOI System**

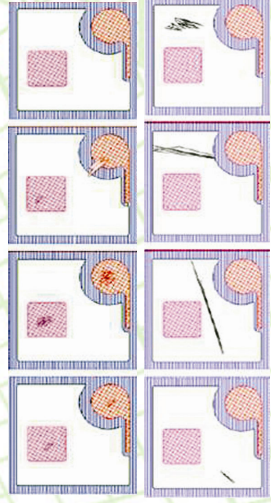

**YT 2800 LED Chip/Wafer/Mask
AOI System**

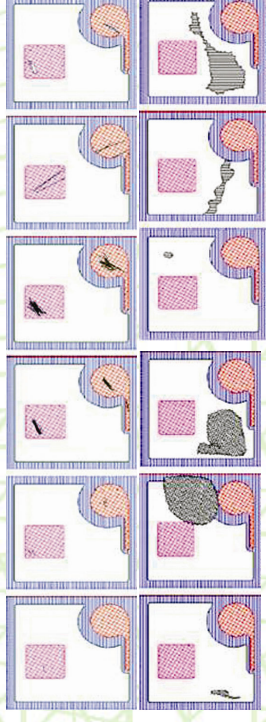

YoungTek Electronics Corp.

Auto Optical Inspection (自動光學檢測系統)

Company Profile

YT 2210 Reel Type Components AOI System

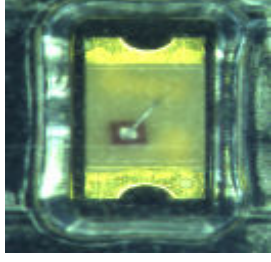

Polarity inverse package

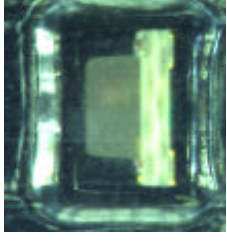

Tilt

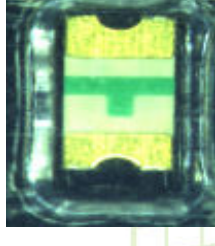

Over turn

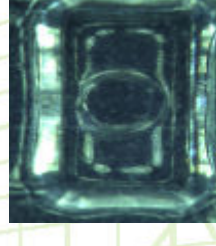

Empty

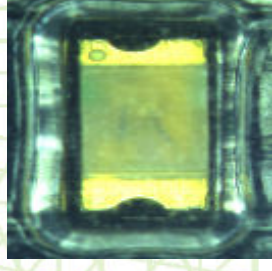

Mixed package



YTEC YoungTek Electronics Corp.

Auto Optical Inspection Application

Company Profile

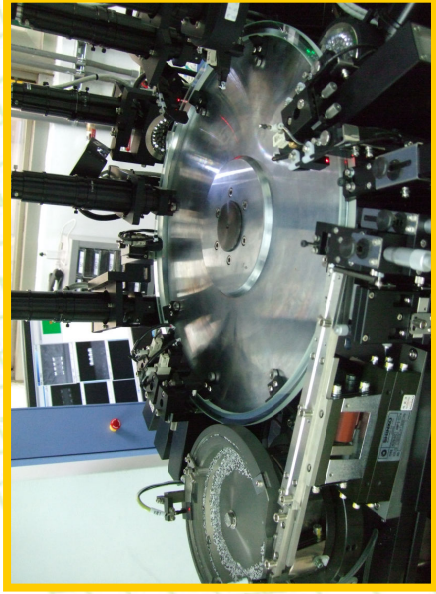
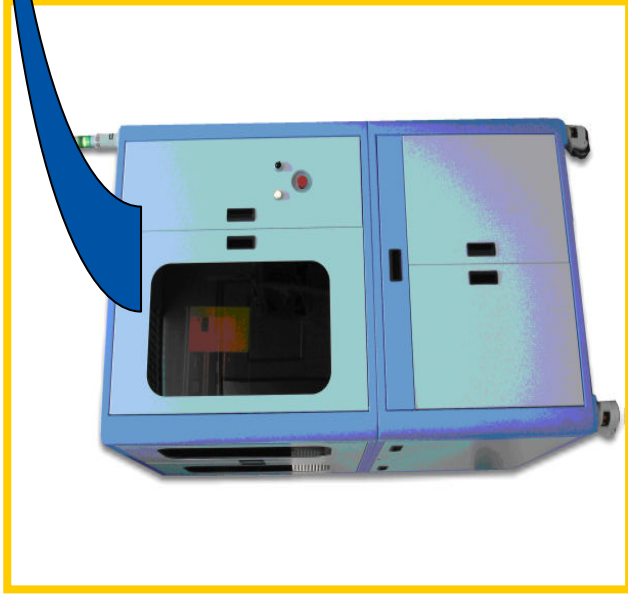

Reel type taped products:

- Resistor
- Capacitor
- Inductor
- LED
- IC
- Relay
- Connector
- Fuse



YoungTek Electronics Corp.

YT2500 LED Dispenser / YT6110 IC Test Handler

Company Profile

YT2500 LED Dispenser



YT6110 IC Test Handler





Company Profile

Revenue Growth



YTEC YoungTek Electronics Corp.

2010&2011 Monthly Revenue

Company Profile

NTS(Thousand)

Business Item/Month	Jan.	Feb	Mar	Apr	May	Jun.	Jul.	Aug.	Sep	Oct.	Nov.	Dec.	Total	Share(%)	
切磨拋檢代工 Sawing & Sorting OEM	2010	87,489	88,907	88,243	90,674	100,946	114,676	125,872	132,127	127,886	113,365	112,967	692,197	43.23%	
	2011	99,641	107,204	131,677	124,662	130,565	128,825	127,673					850,247	46.92%	
	YoY	13.89%	20.58%	49.22%	37.48%	29.34%	12.34%	5.29%						22.83%	
測試代工 Testing OEM	MoM	-11.80%	7.59%	22.83%	-5.33%	4.74%	-1.33%	-0.89%							
	2010	84,827	73,814	106,873	100,877	102,290	111,242	116,253	122,966	110,401	100,108	91,692	696,176	43.48%	
	2011	80,684	66,316	115,541	101,928	110,180	86,142	85,536					646,327	35.67%	
機器組裝等產品 銷售 Own Product Sales	YoY	-4.88%	-10.16%	8.11%	1.04%	7.71%	-22.56%	-26.42%					-7.16%		
	MoM	-12.01%	-17.81%	74.23%	-11.78%	8.10%	-21.82%	-0.70%							
	2010	11,188	10,261	31,037	34,892	39,340	48,127	37,907	49,937	46,023	39,757	28,602	212,752	13.29%	
營業收入淨額 (Unit:K) Sales Revenue (Net)	2011	29,417	49,924	58,053	47,824	46,144	35,405	48,591					315,358	17.40%	
	YoY	162.93%	386.54%	87.04%	37.06%	17.30%	-26.43%	28.18%					48.23%		
	MoM	2.85%	69.71%	16.28%	-17.62%	-3.51%	-23.27%	37.24%							
營業收入淨額 計 Sales Revenue (Total)	2010	183,504	172,982	226,153	226,443	242,576	274,045	275,422	298,775	288,551	257,312	233,261	1,601,125	100.0%	
	2011	209,742	223,444	305,271	274,414	286,889	250,372	261,800					1,811,932	100.0%	
	YoY	14.30%	29.17%	34.98%	21.18%	18.27%	-8.64%	-4.95%					13.17%		
總體代工成長 OEM Growth (Total)	MoM	-10.08%	6.53%	36.62%	-10.11%	4.55%	-12.73%	4.56%							
	2010	183,504	356,486	582,639	809,082	1,051,658	1,325,703	1,601,125	1,899,900	2,188,451	2,458,202	2,715,514	2,948,775	--	
	2011	209,742	433,186	738,457	1,012,871	1,299,760	1,550,132	1,811,932						--	
總體代工成長 OEM Growth (Total)	YoY	14.30%	21.52%	26.74%	25.19%	23.59%	16.93%	13.17%							
	2010	172,316	162,721	195,116	191,551	203,236	225,918	237,515	248,838	242,528	229,994	213,473	204,659	1,388,373	
	2011	180,325	173,520	247,218	226,590	240,745	214,967	213,209						1,496,574	
YoY	4.65%	6.64%	26.70%	18.29%	18.46%	-4.85%	-10.23%								
	MoM	-11.89%	-3.77%	42.47%	-8.34%	6.25%	-10.71%	-0.82%						7.79%	



YoungTek Electronics Corp.

2001~2010 Revenue Growth

Company Profile

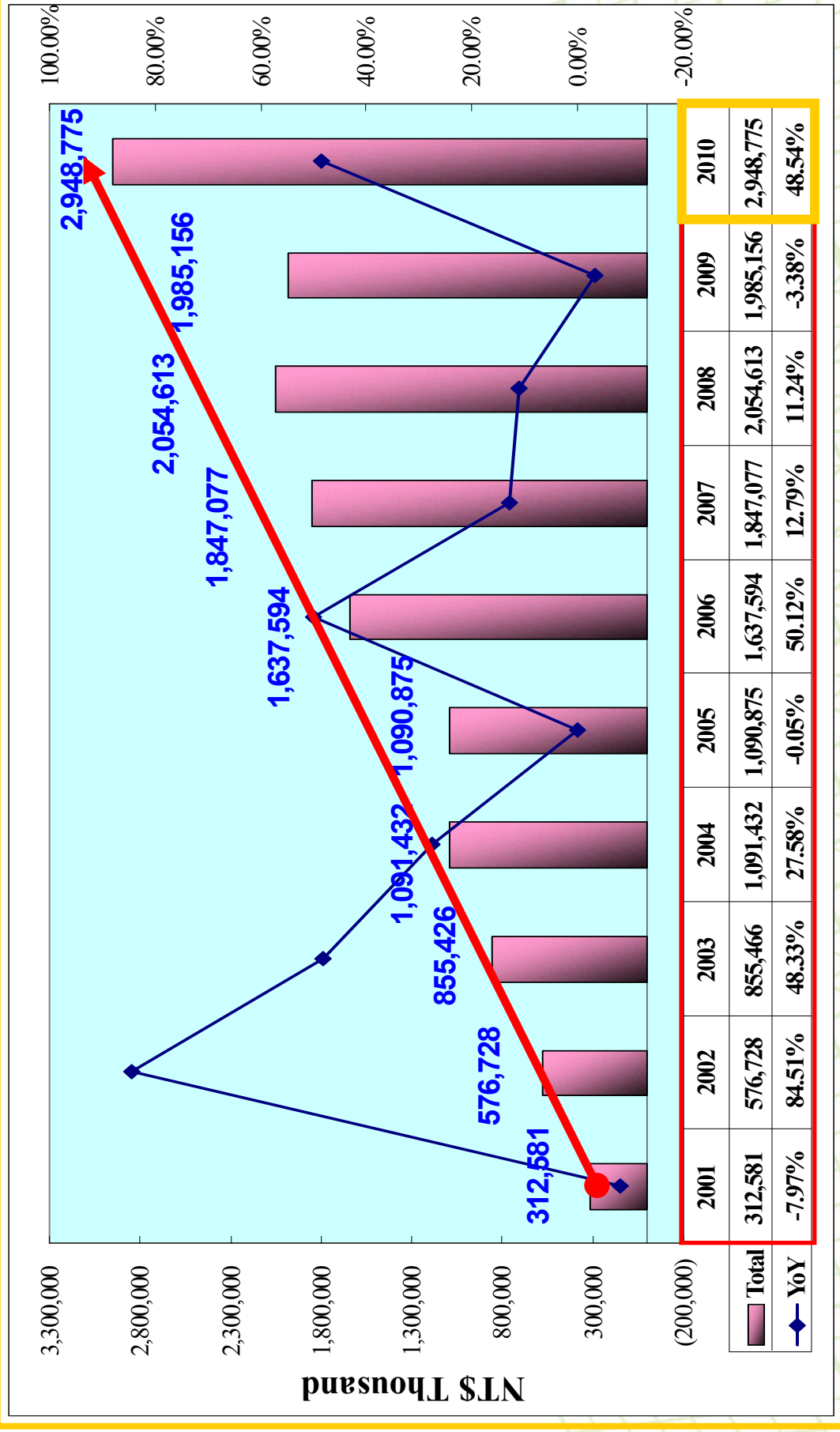

YoungTek Electronics Corp.

2010/2011 Gross Profit

Company Profile

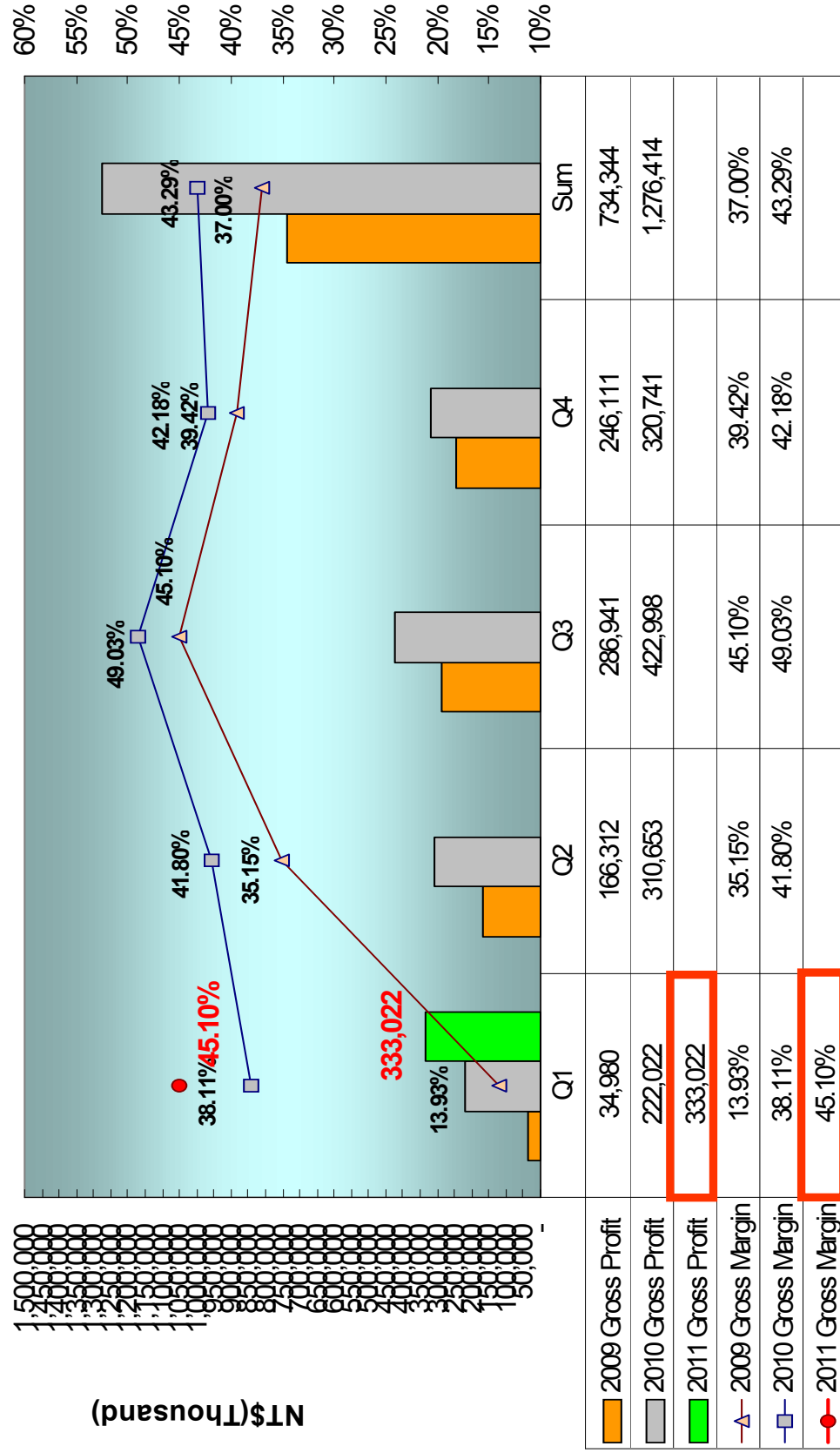

Share payout composition and history

Company Profile

Year	九十三年度 (2004)	九十四年度 (2005)	九十五年度 (2006)	九十六年度 (2007)	九十七年度 (2008)	九十八年度 (2009)	九十九年度 (2010)	100年度 (2011)
	九十二年 Profit(2003)	九十三年 Profit(2004)	九十四年 profit(2005)	九十五年 Profit(2006)	九十六年 Profit(2007)	九十七年 Profit(2008)	九十八年 Profit(2009)	九十九年 Profit(2010)
Cash(NID)	\$3.00	\$3.00	\$2.61	\$4.00	\$4.00	\$3.00	\$3.00	\$4.67
Free Pair stock	\$2.00	\$2.00	\$0.87	\$1.00	\$0.50	\$0.10	\$0.10	
Stock Capital reserve fund	-	-	-	-	--	-	--	\$0.09
EPS(NID)	\$7.28	\$8.24	\$5.56	\$8.61	\$7.41	\$6.09	\$4.07	\$8.53



公司願景Company Mission

Company Profile

著眼於國內外市場的開拓，讓久元成爲立足台灣
的整合性後段IC及LED代工服務廠，並朝放眼
世界的自有產品、自有品牌邁進。

Based on the domestic and international marketing development, YTEC has gotten a foothold as an integrated back-end IC&LED OEM factory. YTEC moves forward, with it's own products, and Own Bench Marks.

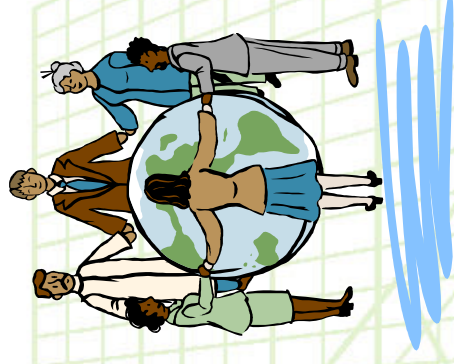

YTEC YoungTek Electronics Corp.

Q & A

Company Profile

Thank you very much



YoungTek Electronics Corp.